



Potential for Energy Storage in Combination with Renewable Energy in Latin America and the Caribbean

Lenin Balza
Christiaan Gischler
Nils Janson
Sebastian Miller
Gianmarco Servetti

**Inter-American
Development Bank**

Infrastructure and
Environment
Department
Energy Division

TECHNICAL NOTE

No. IDB-TN-626

February 2014

Potential for Energy Storage in Combination with Renewable Energy in Latin America and the Caribbean

Lenin Balza
Christiaan Gischler
Nils Janson
Sebastian Miller
Gianmarco Servetti



Inter-American Development Bank

2014

Cataloging-in-Publication data provided by the
Inter-American Development Bank
Felipe Herrera Library

Potential for energy storage in combination with renewable energy in Latin America and the Caribbean /
Lenin Balza, Christiaan Gischler, Nils Janson, Sebastian Miller, Gianmarco Servetti.

p. cm. — (IDB Technical Note ; 626)

Includes bibliographic references.

1. Energy storage—Caribbean Area. 2. Energy storage—Latin America. 3. Electric power distribution—
Caribbean Area. 4. Electric power distribution—Latin America. 5. Renewable energy source—Caribbean
Area. 6. Renewable energy source—Latin America. I. Balza, Lenin. II. Gischler Blanco, Christiaan. III.
Janson, Nils. IV. Miller, Sebastián. V. Servetti, Gianmarco. VI. Inter-American Development Bank. Energy
Division. VII. Title. VIII. Series.

IDB-TN-626

<http://www.iadb.org>

The opinions expressed in this publication are those of the authors and do not necessarily
reflect the views of the Inter-American Development Bank, its Board of Directors, or the
countries they represent.

The unauthorized commercial use of Bank documents is prohibited and may be punishable under
the Bank's policies and/or applicable laws.

Copyright © 2014 Inter-American Development Bank. All rights reserved; may be freely
reproduced for any non-commercial purpose.

Abstract*

Can energy storage (ES) increase the share of renewable energy (RE) in total generation in Latin America and the Caribbean (LAC)? The rationale for using ES in combination with RE in the LAC region is that it can enable a larger scale deployment of cost-saving intermittent RE, with which the region is highly endowed, without threatening grid stability or the ability to meet electricity demand. To test this rationale, the paper considers three case studies that represent the key market types in LAC: a small off-grid town, a small island country, and a large interconnected market. ES technologies can increase the share of intermittent RE in total generation by: (i) providing backup power at times when intermittent RE technologies cannot generate power (to maintain grid stability); and/or (ii) providing energy management services that allow system operators to forecast when they will be able to use electricity from intermittent RE (to maintain the ability to meet electricity demand at all times).

Keyword: Energy Storage, Renewable Energy, Energy Storage Technologies, Latin American and Caribbean countries.

JEL Codes: Q20, Q40, O54

* The views expressed herein are those of the authors and do not necessarily reflect those of the institutions with which they are affiliated. Any remaining errors are the authors' responsibility. Corresponding author: CHRISTIAANG@iadb.org, address: 1300 New York Avenue, N.W. Washington, DC 20577; phone: 1-202-623-3411.

1 Introduction

Can energy storage increase the share of renewable energy in total generation in Latin America and the Caribbean? The objective of this paper is to assess whether energy storage (ES) is a technically feasible and economically viable option for increasing the share of renewable energy (RE) generation in the region. This paper aims to determine how can ES increase the share of RE in total generation? How much can ES increase the share of RE in total generation? When can ES be economically viable?

Energy storage technologies that provide backup power and energy management services enable larger deployment of intermittent renewable energy capacity without threatening either grid stability or the ability to meet electricity demand. The LAC region is endowed with a variety of abundant RE resources, and there is a vast, untapped potential for generating electricity from RE sources at a lower cost than the avoided cost of conventional generation.

It is well known that generation pattern of technologies powered with intermittent energy sources can vary greatly, quickly, and unpredictably—in contrast to conventional technologies, for which generation can be adjusted to produce specific amounts of power at specific times based on electricity demand fluctuations. As a result, grid stability concerns limit intermittent RE options—such as utility scale solar PV and utility scale wind—from reaching their full potential. However, ES technologies can increase the share of intermittent RE in total generation by providing backup power when intermittent RE technologies become unavailable unexpectedly and/or providing energy management services, which allow grid operators to use lower-cost RE generated off-peak to meet peak electricity demand.

We have developed an electricity generation dispatching model to examine the effect of combining RE with ES. The model explores three cases representative of the different power markets in LAC: a small off-grid town (in Colombia), a small island country (Barbados), and a large inter-connected grid (Mexico). For each case study, the model generates a Business as Usual Scenario ('BAU'), an optimized level of RE scenario without ES ('RE without ES'), and an optimized level of RE with ES scenario ('RE with ES'). The model also scales up the results of the case studies where RE with

ES is economically viable to electricity markets similar to the case studies throughout the region, to determine the potential impact of using ES with RE to increase the share of RE in total generation in the region.

Case studies analyzed in this paper, based on an electricity generation dispatching model, suggest that: RE without ES reduces the cost of electricity compared to a Business As Usual scenario in all cases. For the small off-grid town and small island country, renewable energy with energy storage, increases the share of RE in total generation more than RE without ES, without increasing the cost of electricity. Also, costs less than using spinning reserve to provide backup for RE. For large inter-connected countries, RE with ES seems not economically viable, and needs significant lower costs of ES or RE, and/or higher costs of conventional energy to become viable.

The rest of the paper is as follow: Section 2 describes and Analyzes Energy Storage Technologies. Section 3 offers an overview of the current energy storage projects servicing renewable energy in LAC. Section 4 models energy storage with renewable energy in LAC. Finally Section 5, offers some policies actions to exploit the potential of combining renewable energy with energy storage.

2 Describing and Analyzing Energy Storage Technologies

ES technologies desirable for combining with RE can provide backup and energy management services; they must also be economical (2.1). Screening ES technologies for these characteristics determines that lead-acid battery, sodium-sulfur (NaS) battery, and pumped hydro storage (PHS) technologies are appropriate for being used in combination with RE (2.2). However, ES technologies are only appropriate for a specific electricity market if they are screened to be economically viable in the context of that electricity market (2.3).

2.1 Desirable Features of Energy Storage Technologies for RE

ES technologies that can provide backup power and energy management services are technically capable of increasing the share of RE in total generation. Therefore, technologies that can generate electricity rapidly enough to provide backup power and store enough electricity to discharge it over a long enough time to offer energy management services—at least several hours—are appropriate for pairing with RE. Finally, for an ES technology to be economically viable it must not be too expensive to install and maintain.

Key features that determine if ES is appropriate for RE are:

Fixed cost of storage in US\$ per kWh—this is the cost to store electricity that is directly attributed to the ES system itself. This cost accounts for the capital cost and fixed operation and maintenance costs of the ES technology:

- **Unit capital cost** in US\$ per kWh—this is the capital cost of the technology for each kWh of electricity that it can store. For modular technologies, such as batteries, the unit capital cost can be approximated very uniformly; however, technologies such as PHS are very site-specific. The unit capital cost can also be expressed as the cost per kW of discharged power (accounting for the strength of the electric current). For electrochemical ES

technologies (batteries), kWh and kW are interchangeable. This is because batteries can be discharged all in the course of an hour or over a longer period of time. Non-electrochemical ES technologies, however, cannot be discharged fully within one hour. This paper measures the capital cost of non-electrochemical technologies in US\$ per kWh

- **Operation and maintenance cost (O&M cost)** in US\$ per kW per year—the annual cost of operating and maintaining each kW of capacity.

It is important to note that calculating the full cost of generating, storing, and discharging a kWh of electricity requires accounting for other costs in addition to this fixed cost—such as the cost of Balance of System equipment required to integrate the ES technology into the grid ('BoS cost'), the cost of generating the electricity that is being stored, and the cost of electricity that is lost in storage. BoS costs can be significant, ranging from 30 percent to up to 400 percent more than the cost of an ES technology alone

Roundtrip efficiency in percentage—every storage technology requires more energy to charge than it can discharge. Roundtrip efficiency represents this loss of energy; it is calculated as the ratio of energy discharged from storage to the energy input into storage (IRENA, 2012)

- ✓ **Capacity range** in MW—the range of capacity in which each technology is available. The capacity of some technologies is limited by their physical characteristics—for example, flywheels cannot practically be large enough to have a capacity of over 1MW. In contrast, technologies such as compressed-air energy storage (CAES) always have a capacity higher than 100MW
- ✓ **Lifespan** in years—the amount of time an ES technology can be reasonably expected to last. Determining the lifespan of some ES technologies in years involves making assumptions on their frequency of use. For example, the lifespan of electrochemical technologies (batteries) is typically listed in cycles—meaning that the frequency of use determines their lifespan. PHS has a more predictable lifespan based on the durability of its turbines and piping equipment

- ✓ **Duration** in hours—the amount of time during which each ES technology can discharge electricity at its rated capacity. This indicator ranges from 10 seconds to a full day. Duration is an important characteristic to take into account when choosing an ES technology.

Unit capital cost, O&M costs, lifespan, and roundtrip efficiency all impact the cost of storing electricity in the ES technology. In general, a low unit capital cost and O&M costs, which lower fixed costs, are desirable; conversely, a high lifespan and round trip efficiency lower costs by extending the repayment period and decreasing the cost of electricity that goes into storage respectively. Finally, a reasonable duration, of at least several hours, is required for ES technologies to be able to provide energy management services.

2.2 Screening Energy Storage Technologies for RE in LAC

Based on the criteria established in Section 2.1, lead-acid battery storage, NaS battery storage, and PHS are appropriate for combining with RE. Table 2.1 below compares the different storage technologies based on the features listed in Section 2.1.

All ES technologies considered in this paper are presented in detail in Appendix A.

Based on the comparison, the table shows:

Advantages and drawbacks of each ES technology—each technology has specific characteristics, some of which can be considered advantages, some of which are drawbacks. Choosing the most appropriate technology requires careful consideration of these advantages and drawbacks

Purposes that each technology is most appropriate for—these include improving the provision of backup, improving energy management, power quality—stabilizing the frequency and voltage of electricity on the grid—and deferring transmission and distribution investment—by storing electricity close to the load and discharging it when transmission and distribution systems are most burdened

If each ES technology is appropriate for use in combination with RE—ES technologies that can provide energy management and backup storage are most appropriate for combining with RE.

Table 2.1: Overview of Energy Storage Technologies

Technology	Fixed Cost (US\$/kWh or kW)	Unit Capital Cost (US\$/kWh)	Annual O&M Costs (US\$/kW)	Capacity Range (MW)	Duration (Hours)	Lifespan (Years)	Roundtrip efficiency (%)	Advantages	Drawbacks	Purposes	Good for RE
Deep-Cycle Lead Acid batteries	0.25-0.35	150-500	30	≤10	1-8	3-10	70-90	Cheap, Many Uses	Short Lifespan, Limited Capacity	PQ, T&D, Backup, EM	✓
Lithium-ion batteries	0.30-0.45	500-1,500	25	≤21	4-8	10-15	85-95	Efficient, Many Uses	Limited Capacity	PQ, T&D, Backup	✓
NaS batteries	0.05-0.15	125-250	15	≥100	4-8	15	80-90	Large Capacity, Many Uses	Expensive	PQ, T&D, EM, Backup	✓
Flow batteries	0.15-0.25	350-800	30	.025-10	1-8	10-20	70-85	Customizable Capacity, Many Uses	Expensive, Limited Capacity	PQ, T&D, Backup	✓
Pumped Hydro Storage	0.05-0.15	1,000-4,000	15	≥50	4-24	40	75-85	Cheap, Large Capacity	Difficult Siting	Backup, EM	✓
Compressed Air Energy Storage	0.10-0.20	800-1,000	5	≥100	4-24	30	45-60	Cheap, Large Capacity	Difficult Siting, Inefficient	EM	✓
Thermal Energy Storage	0.18-0.22	700-900	10	n/a	8-10	20	~100	Efficient	Difficult Siting, Not Commercial	EM, Backup	✓
Flywheels	n/a	2,000-4,000	5	.1-2	<1	20	85-95	Efficient, Responsive	Short Duration, Expensive	PQ	
Hydrogen storage	n/a	1,000	n/a	.1-10	≤24	20	25-35	Many Uses	Expensive, Inefficient, Not Commercial	Backup, EM	✓
Superconducting Magnetic Energy Storage	n/a	n/a	n/a	.2-4	.003	40	90-99	Responsive, Efficient	Expensive, Short Duration	PQ	

RE=Renewable Energy, PQ=Improving Power Quality, Backup=Providing Backup, EM=Improving Energy Management, T&D=Deferring transmission and distribution investment

Source: IRENA 2012, NREL 2010, APS 2007

All technologies examined in this table above, with the exception of Superconducting Magnetic Energy Storage (SMES) and flywheels, are technically appropriate for increasing the share of generation from intermittent RE in electricity systems. Li-Ion batteries and lead-acid batteries are best for small grid RE applications. NaS batteries are best for combining with RE in large grids where PHS and CAES are not feasible. Flow batteries are best for combining with RE for long-term investments in small grids where ES capacity needs may change over time. Hydrogen storage and thermal energy storage are not yet commercially available, but they are promising technologies that may become technically feasible over time, and which may become useful for reducing fossil fuel use for generating electricity, powering cars, and providing heat.

Among the technologies that are technically feasible, technologies that provide good duration and are inexpensive relative to other ES technologies are the most desirable for combining with RE. Figure 2.1 below identifies the most desirable ES technologies for combining with RE.

Figure 2.1: Duration Compared to Unit Capital Cost for ES Technologies

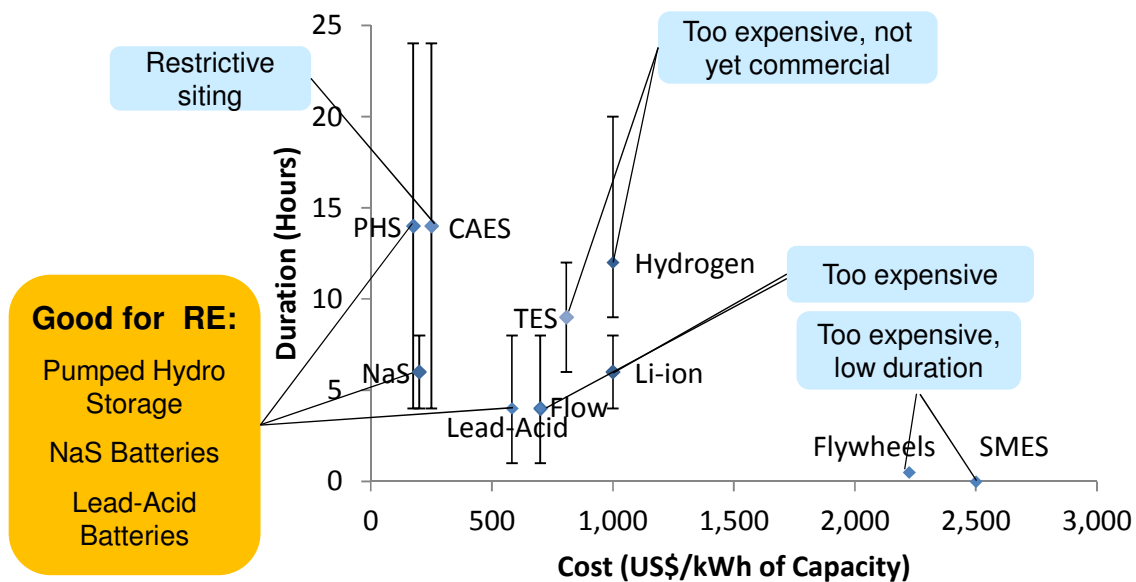

Note: CAES: Compressed-Air Energy Storage; Flow: Flow Battery; Lead-Acid: Lead-Acid Battery; Li-ion: Lithium Ion Battery; NaS: Sodium-Sulfur Battery; PHS: Pumped Hydro Storage; SMES: Superconducting Magnetic Energy Storage; TES: Thermal Energy Storage

The figure above screens PHS, NaS batteries, and lead-acid batteries for pairing with RE. Of the technologies screened in, capacity range constraints dictate that PHS is best for large ES installations, NaS battery storage is best for large installations where PHS is not available, and lead-acid batteries are best for small ES installations. CAES is screened out for its very restrictive siting, which requires salt caverns or some other underground structure in which to compress air. All other technologies are screened out for being too expensive relative to other technologies—as well as for their low duration in the case of flywheels and SMES; and for lack of commercial availability in the case of TES and hydrogen.

2.3 Screening ES Technologies for Economic Viability in LAC

ES technologies can increase the share of renewables in total generation without increasing the cost of energy for the grid as a whole if their costs of installation, operation, and maintenance are offset by the benefits they provide. The benefits of combining ES with renewables can accrue from two services: backup power, and energy management services. The sections below examine the economic viability of ES technologies that can provide these services. As noted in section 2.1, some technologies, such as lead-acid batteries, can provide both services.

2.3.1 Economic viability of ES providing backup power

As previously mentioned, backup power eliminates or reduces the need to constrain the share of intermittent RE in total generation. For an ES technology that provides backup power for RE to be economically viable, the value of the savings accrued from using additional RE to generate electricity (instead of conventional generation) must be larger than the cost of installing and maintaining the ES system.

Assuming that a system operator would, in the absence of backup power, limit the share of intermittent RE to 15 percent of electricity demand, the benefit of an ES technology that provides backup power is therefore equivalent to the cost savings realized as a result of the RE supply provided above the 15 percent constraint. The function below describes how to quantify this benefit:

Benefit of Backup

$$= \sum_{i=1}^{24} [(Supply_{RE,i} - 15\%_{demand}) \times (LRMC_{RE} - Avoided\ cost_{RE,i})] \\ \times 365 \times ES_{lifespan}$$

Where:

- ✓ $Supply_{RE,i}$ is the total amount of RE generation supplied to the grid within hour i —assuming that the amount of RE capacity is determined so as to minimize the cost of electricity supply required for meeting the system’s daily load
- ✓ $15\%_{demand}$ corresponds to the constraint on RE generation that is required when backup power is not available. Below this constraint, RE can be added to the grid without requiring backup—therefore, ES does not get credit for benefits accrued from RE generation below that constraint
- ✓ $LRMC_{RE}$ is the Long-Run Marginal Cost (LRMC) of RE capacity installed, which includes a capital cost recovery factor per kWh, as well as fixed and variable operation and maintenance (O&M) costs
- ✓ $Avoided\ cost_{RE,i}$ is the avoided cost of conventional generation that the RE supply displaces. This corresponds to the short run marginal cost (SRMC) of conventional generation, which includes the weighted average fuel cost and variable O&M cost per kWh of the conventional plants that the RE generation displaces
- ✓ $ES_{lifespan}$ is the number of years that the ES system will last.

The above equation shows that the ES technology generates benefits for each kWh of RE generated above 15 percent of demand if the LRMC of the RE capacity ($LRMC_{RE}$) is lower than the avoided cost of conventional generation ($Avoided\ cost_{RE,i}$).

The breakeven cost of an ES technology that provides backup power for RE is the cost at which the benefit derived from a unit of backup power is equivalent to the cost of

providing that unit of backup power (including the capital cost, cost of balance of systems equipment, operations and maintenance cost, and financing costs of this backup capacity). On this basis, and given the equation shown above, we can determine the breakeven cost of an ES technology (in terms of unit capital cost) given a specific electricity system size, optimized amount of RE capacity, and cost of RE and conventional generation. By varying the assumption regarding the avoided cost of conventional generation, we can build a ‘breakeven cost curve’ that shows the breakeven unit capital cost of ES which corresponds to different avoided costs of conventional generation.

Figure 2.2 below shows the breakeven cost curve for ES in Barbados’s electricity system. At any point on the breakeven cost curve, the net benefit of using ES to backup RE amount to zero—meaning that the benefit of providing backup services is equivalent to the cost of installing and operating the ES system. The ES technology—in this case, a lead-acid battery system—is viable if the point representing the combination of the technology’s unit capital cost and the avoided cost of generation is located on or below the breakeven cost curve. It is important to note that the figure shown below is produced based on assumptions regarding RE resources and costs, conventional generation mix, and appropriate ES technology that are specific to Barbados—therefore, it cannot be interpreted as a general breakeven cost curve for using ES to backup RE in any given country.

Figure 2.2: Breakeven Unit Capital Cost of ES in Barbados

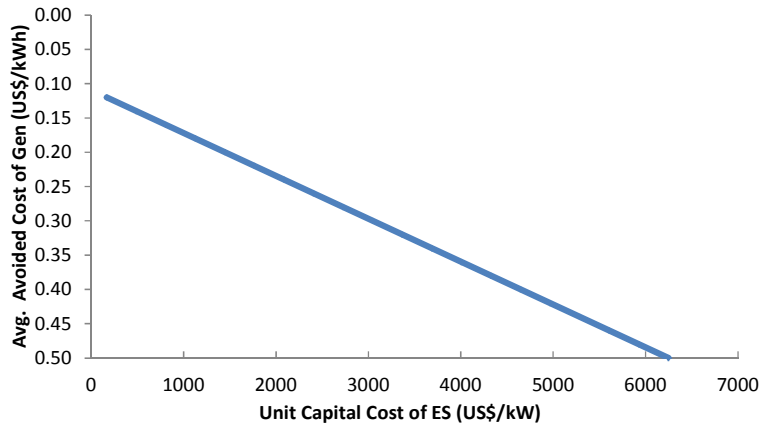

Assumptions: Discount rate of 10 percent; lead-acid battery ES system of 75.6MW; wind power system of 213.4MW; LRMC of utility scale wind of US\$0.10 per kWh; O&M cost of ES of US\$30 per kW per year; lifetime of ES system of 12.3 years; roundtrip efficiency of 80 percent.

Note: The average avoided cost of generation corresponds to a weighted average of avoided cost based on RE displacement of peak, shoulder, or base load capacity.

The figure above shows that the greater the positive difference between *Avoided cost*_{RE,i} and *Supply*_{RE,i}, the greater the benefit derived over the lifetime of the ES system (given that the amount of RE generation is the same for all points along the curve). Therefore, a higher avoided cost of conventional generation results in a higher breakeven cost of ES, all else equal (and vice versa).

2.3.2 Economic viability of ES providing energy management services

An ES technology that provides energy management services for RE can increase the share of RE in total generation without increasing the cost of energy for the grid as a whole when the Levelized Cost of Energy Storage (LCOES) is less than the avoided cost of conventional generation. Therefore, an ES technology providing energy management services is screened in as economically viable when its LCOES is less than its cost of avoided generation.

The LCOES is calculated as follows:

$$LCOES = \left(\frac{C_{gen.}}{RT \text{ Eff.}} \right) + Fixed \text{ Costs}_{storage} + C_{BoS}$$

Where: $C_{gen.}$ is the cost of energy stored

$RT\ Eff.$ is the roundtrip efficiency of the storage unit

$Fixed\ Costs_{storage}$ is the capital and average annual O&M cost of the ES

C_{BoS} is the Balance of Storage cost.

The figure below shows the breakeven cost per kWh for fixed cost of each ES technology at each avoided cost of generation.

Figure 2.3: Breakeven Costs for RE with ES

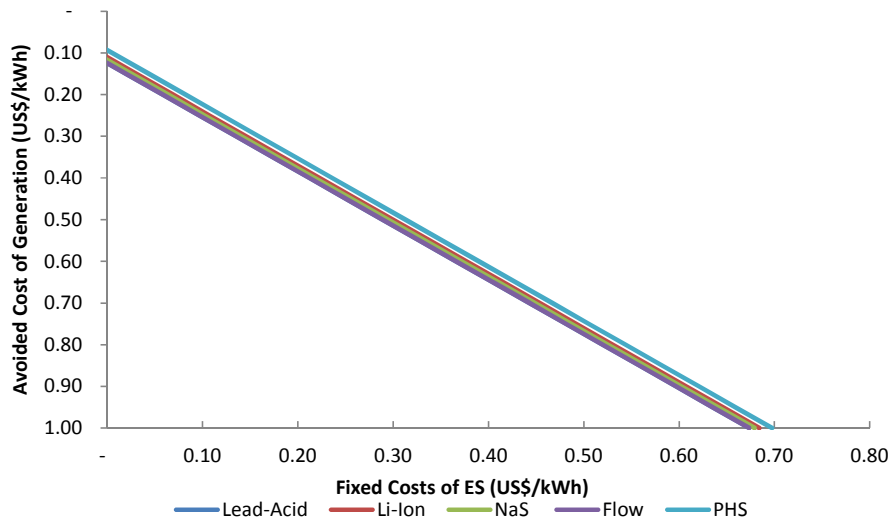

- (1) Lead-Acid: Lead-Acid Batteries; Li-Ion: Lithium-Ion Batteries; NaS: Sodium-Sulfur Batteries; Flow: Flow Batteries; and PHS: Pumped Hydro Storage
- (2) The analysis assumes a cost of generation of US\$0.10 for utility scale wind
- (3) The analysis assumes a roundtrip efficiency of 80 percent for Lead-Acid Batteries, Flow Batteries, and Pumped Hydro Storage; 85 percent for Sodium-Sulfur Batteries; and 90 percent for Lithium-Ion Batteries
- (4) The analysis assumes a BoS cost of 30 percent of Fixed Costs

At any point on each technology's breakeven cost curve, the LCOES equals the avoided cost of conventional generation. An ES technology is viable if its fixed costs and the avoided cost of generation are represented by a point that is below the line; an ES technology is not economically viable if its fixed costs and the avoided cost of generation are represented by a point that is above the line.

The figure shows how much additional cost per kWh ES can add to the cost of RE per kWh without raising the LCOES above the avoided cost of generation. For example,

when the avoided cost of generation is US\$0.10, which is equal to the assumption made for the cost of RE generation, the maximum fixed costs of ES is US\$0. If ES added any extra cost, it would push the LCOES above the avoided cost of generation. The graph shows that for each technology there is a consistent relationship between avoided cost of conventional generation and the fixed costs of ES. The difference in roundtrip efficiency explains the minor differences in the curves.

3 Current Energy Storage Projects Servicing Renewable Energy in LAC

The experience in the LAC region supports our analysis, according to which lead-acid batteries and Li-ion batteries should be used for small ES installations, and that NaS batteries should be used in larger installations where PHS is not an option. The only exceptions are several projects in Argentina that use hydrogen. However, these are pilot projects not intended to be economically viable. For this reason, they are not discussed further.

Table 3.1 below provides an overview of operating and planned ES projects in LAC, classified as follows:

- ✓ ‘Off-grid’—for installations that are not connected to a distribution grid
- ✓ ‘Small grid’—for installations that are connected to a distribution grid and intended to serve small populations of less than 1,000 people
- ✓ ‘Large inter-connected grid’—for installations that are connected to a transmission grid.

The table also shows that the ES technologies are used primarily energy management and backup power.

Table 3.1: Energy Storage Installations in LAC

Scale	Operating/ Planned	Pilot*	Country	Technology	Capacity	Purpose	RE
Off-grid	Operating	No	Grenada	Li-ion	Unknown	Energy management, Backup	Yes
	Operating	No	Peru	Lead-acid	Unknown	Energy management, Power quality, Backup	Yes
Small scale	Operating	No	Bahamas	Lead-acid	4MWh	Energy Management, Power quality, Backup	Yes
	Operating	No	Mexico	Lead-acid	Unknown	Energy Management,	Yes

						Power quality, Backup	
	Operating	Yes	Argentina	Hydrogen	Not defined	Energy Management, Fuel for vehicles, heating	Yes
	Planned	Yes	Argentina	Hydrogen	Not defined	Energy Management, Fuel for vehicles, heating	Yes
	Planned	No	Argentina	Hydrogen	Not defined	Energy Management, Fuel for vehicles, heating	Yes
Large Inter-Connected Grid	Operating	No	Bonaire	Nickel-based	3MW	Energy Management, Power quality, Backup	Yes
	Planned	No	Ecuador	Not Defined	700kW	Energy management, Power quality, Backup	Yes
	Operating	No	Chile	Li-Ion Battery	12MW	Power quality, Backup	No
	Operating	No	Chile	Li-Ion Battery	20MW	Power quality, Backup	No
	Planned	No	Mexico	NaS Battery	1GWh	Energy management	Yes

The table shows that most projects offer both backup and energy management services—the two services relevant for RE with ES; one project offers only energy management services combined with RE; two projects offer backup services only (in addition to power quality); and no project offers only backup paired with RE.

3.1 Projects Providing Backup Services and Energy Management Services

Every small scale or off-grid ES installation combined with intermittent RE in LAC combines both backup and energy management services. This is because electricity grids that use a high share of RE in total generation require back up power when intermittent RE is unavailable. In addition, all of these locations have high avoided costs of conventional generation. Therefore, using energy management (time shifting) to increase the amount of RE to offset expensive conventional generation is economically viable. The examples below show the different ways ES has been combined with RE in LAC to provide backup and energy management services.

Outside of the LAC region, economically viable programs that offer backup and energy management services are being implemented. The Government of Portugal is working with Younicos, a private RE with ES implementer, to set up and secure the financing for a special project company, which will invest an initial amount of 25 million euros in a renewable energy system. The system is expected to save Portugal 1.5 million Euros over the project's 20-year lifespan by replacing expensive diesel generation. The starting system layout will comprise a 5.4 MW wind park, a 500 kW solar plant, 2.5 MW of NaS battery storage, and balance of systems equipment developed by Younicos. The project is scheduled to be operational by 2014 and will cover 70 percent of the 13 GWh of energy consumed on Graciosa annually. Diesel generation will be maintained for the remaining 30 percent and as a back-up system. (Younicos, 2012)

3.1.1 Bahamas, Lead-acid batteries (4MWh)

In April 2010, Optimal Power Solutions (OPS) commissioned a lead-acid battery system with a capacity to store 4MWh in Over Yonder Cay, Bahamas (Optimal Power Systems, 2012). The system is part of a micro-grid that combines 240kW of solar photovoltaic (PV) arrays, eight 15kW wind turbines, and three 312kW diesel generators. The system is controlled by OPS Hybrid Power Conditioner central inverters (Optimal Power Systems, 2009).

The solar PV panels and battery system are typically able to support the load during the day and night without the need for diesel generation, leading to a reduction in the cost of electricity (Optimal Power Systems, 2012).

3.1.2 Mexico, Lead-acid batteries

In 1999 in San Juanico, Mexico, local utilities working with local civic groups and international donors funded and installed a hybrid electricity system. The system comprises a 17kW solar PV array; a flooded lead-acid battery bank; ten wind turbines, with a total rated capacity of 70kW; and an 80kW diesel generator.

The system provides 24 hour power, replacing a 205kW diesel generator installed in 1980, which provided electricity for three to four hours per day. The hybrid installation has reduced energy costs for the grid, and is considered a success by local residents—

despite issues related to the frequent need for replacing the lead-acid batteries, which have short lifespans (IRENA, 2012).

3.1.3 Peru, Lead-Acid Batteries

ILZRO RAPS Peru ('RAPS'), a local NGO, is using a SunGel VLRA gel lead-acid battery system in Padre Cocha, Peru, as part of a Remote Area Power Supply program targeting small indigenous communities with limited electricity service. RAPS chose lead-acid batteries because they are a commonly used technology that can easily be replaced by suppliers in local markets.

RAPS uses diesel generators and solar PV arrays in combination with the advanced lead-acid batteries. Previously, the villages used only diesel generators that supplied energy for only four to five hours per day. The program has resulted in a substantial increase in service quality and 24-hour electricity. However, the program is financially unsustainable (IRP, 2008).

3.1.4 Bonaire, Nickel-based battery (3MW)

In Bonaire, the Saft battery company installed a 3MW ES system comprising an advanced nickel-based battery technology (Saft Batteries). The ES system is fed by a 11 MW wind farm and a 14 MW diesel/biodiesel power plant. It stores energy from the island's power grid and then delivers it, as required, to provide reliable and stable power supply (EDIN). The grid serves a local population of 14,500 people and around 100,000 tourists a year. Peak demand is approximately 11MW and annual consumption is 75,000MWh (EDIN).

3.1.5 Ecuador (700kW)

The Government of Ecuador has proposed to develop a 700kW ES system consisting of inverters and a battery bank on the island of Isabela, in the Galapagos Islands. The Government plans to use this system in combination with a hybrid energy generating system comprising a conventional 1.2MW combustion engine generator (running on diesel, jatropha oil, and pure vegetable oil) with a 1.1MW solar PV array. The Government is planning to develop this project with financial support from the German bank KfW (Price, 2012).

3.1.6 Grenada, Li-Ion

In September 2010, the National Water and Sewage Authority of Grenada (NAWASA) contracted the Meeco Group to install an ES system in combination with two solar PV installations to power water treatment plants in the off-grid areas of Les Avocats and Mamma Cannes. NAWASA was previously using diesel generators to power the water treatment plants.

The Meeco Group installed Li-ion batteries because they have a greater lifespan and lower maintenance requirements than other electrochemical storage options—two important characteristics when considering installations in a remote area. NAWASA reports that its investment in the solar PV and ES systems was repaid within two years following installation (Trutschler, 2012).

3.2 Project Providing Energy Management Services

There is one very large ES installation combining with intermittent RE that will only offer energy management services. The Rubenius Group—a private Dubai-based company—is planning on building a 1GWh ES installation in Mexicali. The installation is connected to Mexico's large inter-connected grid and will provide stored power at planned times. The Mexican grid has large enough reserves to make up any difference that could arise on a day when intermittent RE is not sufficient. For that reason, it does not require backup services.

The installation will consist of large NaS batteries providing an 'energy warehouse' for solar PV capacity installed in Sonora State, and wind power installed Baja California State (Marchetti, 2010). This project is expected to be economically viable because it will store large amounts of intermittent RE produced at low cost when the intermittent resource is available, and release it during peak times when the cost of electricity is at its highest.

Construction of the installation began in 2012 with 50MW of storage capacity, and is expected to be completed in 2018. If this installation proves to be a good investment, Rubenius will consider additional facilities with a capacity of between 500MW and 750MW capacity each at congestions sites in central Mexico. At these sites,

the ES capacity would be useful for transmission and distribution deferral purposes (Biller, 2011) in addition to energy management.

Although there are no pumped hydro storage ES projects used for energy management in combination with RE installations in LAC, such projects have proven viable in other countries. For example, in Denmark, wind turbines produce inexpensive electricity when the wind blows during the night. However, Denmark's citizens do not require this energy during the night—so excess electricity is sold and transmitted to Norway via an undersea transmission cable. In Norway, the electricity is stored in PHS installations, and then sold back to Denmark during peak times, at a profit (Mandel, 2010).

3.3 Projects Providing Backup Services

There are only two ES installations in LAC whose that offer backup services and not energy management services. They are not paired with RE, indicating that ES installations that provide only backup services are not acceptable for combining ES with RE. This is partly because ES installers want to be able to take advantage of energy management to use lower-cost RE during peak times. It is also partly due to the fact that any system set up to provide backup power for a period of at least an hour—long enough to ramp up a backup generator—can easily be expanded to provide energy management capacity as well, making it unlikely that an RE installation would choose to forgo this capacity.

Both the installations are Li-ion battery ES installations in Chile used in combination with conventional generation. In the Atacama Desert, Northern Chile, there is a 12MW installation. The installation has improved the reliability of the electric grid by managing fluctuations in demand and delivering frequency regulation in a less expensive, more responsive, and more accurate manner than traditional methods. In addition, because the project replaces unpaid reserve from the power plant by eliminating the need for spinning reserve, AES Gener receives payment for its full output capacity by selling directly to the electric grid (AES, 2009).

In Antofagasta, a 20MW installation builds on the success of the Atacama Desert installation to provide frequency regulation and spinning reserve services to a 544MW thermal power plant (AES Energy Storage, 2012).

These installations are economically viable because they provide higher quality (more valuable) power as well as backup power, thereby deferring the need to invest in additional capacity. Both projects are located in Chile and are collaborations between AES Energy Storage and AES Gener, two subsidiaries of AES Corporation (based in Arlington, Virginia, United States). Electrochemical storage is appropriate for providing reliable power quality support and backup power, and Li-ion batteries are a good option for these installations because they have a higher duration than lead-acid batteries, are less expensive than flow batteries, and a smaller size than NaS batteries.

4 Modeling Energy Storage with Renewables in LAC

The dispatching model answers the research question by determining the potential economically viable increase in the share of RE in total generation that can be achieved using RE with ES. First, the model calculates how much ES can increase the share of RE in total generation for three distinct case studies representative of how ES could be combined with RE in the LAC region. Then, the model scales up the three case studies to calculate the potential benefits for the whole LAC region. The three case studies are the following:

- ✓ Small off-grid town—modeled on the electricity grid of a small town in the Zonas No Interconectadas of Colombia
- ✓ Small island country—modeled on the electricity grid of Barbados
- ✓ Large inter-connected country—modeled on the electricity grid of Mexico, using wind estimates for the area of Oaxaca.

Table 4.1 below shows the key features of each case study:

Table 4.1: Features of the Three Case Studies Combining RE and ES

	1. Small off-grid town	2. Small island country	3. Large inter-connected country
Modeled after	Colombia, off-grid	Barbados	Mexico, Oaxaca
Peak demand	1.4 MW	164 MW	53 GW
Conventional generation	Small Diesel	Low Speed Diesel, Medium Speed Diesel, Gas Turbines	Combined Cycle Gas Turbine, Open Cycle Gas Turbine, Hydro
Appropriate RE	Solar PV	Wind or Solar PV	Wind or Solar PV

Appropriate ES	Lead-Acid Battery	Lead-Acid Battery	Pumped Hydro Storage
----------------	-------------------	-------------------	----------------------

Source: IPSE, BLPC, SENER

The table shows that that the case studies consider electricity grids of very different scale and makeup of conventional energy generation technology—therefore, the findings of the model can be applied in diverse circumstances. In the RE scenario, the model uses only solar PV in the small off-grid town case; and a choice of either solar PV or wind energy in the cases of small island country and large inter-connected country. In the RE with ES scenario, the model uses lead-acid battery storage for the small off-grid town and small island country cases; and PHS for the large inter-connected country case.

4.1 Explaining the Model

The model determines the optimal level of RE and RE with ES for each case study and compares the optimized levels with a Business As Usual (BAU) scenario to determine net benefits. The model determines the scenarios of RE without ES and RE with ES by solving for the greatest positive difference between the daily benefits—the value of electricity sold to the grid—of using RE without ES or RE with ES and the daily cost of implementing RE without ES or RE with ES. In each scenario, the model determines that there is no other amount of RE, or RE combined with ES, that would result in a higher net daily cost savings than the recommended amounts of RE, or RE with ES. If the amount of RE, or RE with ES, determined by the model is greater than zero, then the optimal amounts of RE or RE with ES will save money compared to the BAU scenario.

The difference between the share of RE in total daily generation in the BAU scenario and the share of RE in total daily generation in the RE with ES scenario provides the answer for the research question; comparing the RE without ES scenario ensures that combining RE with ES has a greater daily net benefit than simply optimizing RE. In addition, the model compares the cost of backing up RE with spinning reserve instead of ES to ensure that it would not be less expensive simply to increase the share of RE by using spinning reserve to back it up.

Determining the optimal level of RE and RE with ES for each of three case studies, the model also determines by how much the optimal combinations of RE and RE with ES reduce daily electricity costs, daily conventional generation, and daily carbon dioxide emissions. Finally, after calculating average reductions in daily electricity cost, conventional generation, and tons of carbon dioxide emissions required for meeting electricity demand for each scenario, the model calculates annual reductions of electricity costs, conventional generation, and tons of carbon dioxide emissions by multiplying daily costs by the number of days in a year.

4.1.1 Modeling scenarios

To calculate the daily cost of meeting electricity demand for all three scenarios, the model assumes a standard load profile for each day. The daily load profile is scaled for each case study so that peak demand each day matches peak demand for the electricity grid being for each case study as presented in Table 4.1. Figure 4.1 shows the daily load profile used.

Figure 4.1: Daily Load Profile

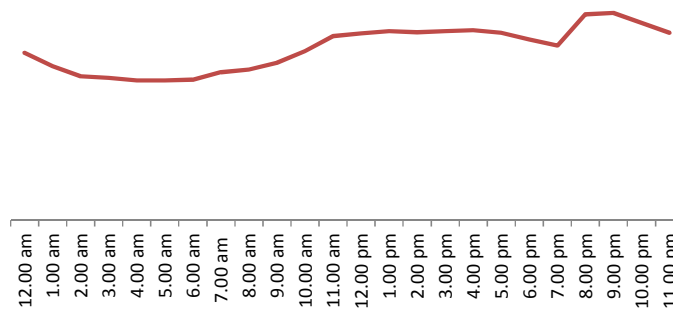

Source: Castalia, *Options to Bring Down the Cost of Electricity in Jamaica*, 2011

The daily load profile represents the electricity demanded by customers, which must be met using the conventional generation technologies, RE technologies, and/or ES technologies available for each case study that are presented in Table 4.1.

Calculating the daily costs of the BAU scenario

Under the BAU scenario, existing electricity conventional generation technologies in each case study are used to supply all electricity demand. The cost to meet electricity demand for each hour of the day therefore corresponds to the cost of existing conventional base load, shoulder, and peak generating units to meet hourly demand—except in the small off-grid town, where there is only one type of generation that meets all demand.

The cost of electricity for an entire day is the product of total electricity demand for the day (in kWh) and the LRMC of generators used to meet demand—where the LRMC includes a capital cost recovery factor per kWh, as well as fixed and variable operation and maintenance (O&M) costs, and fuel costs:

$$\begin{aligned} \text{Cost per day} = & (\text{LRMC}_{\text{baseload}} \times \% \text{ of daily generation met by baseload gen.}) \\ & + (\text{LRMC}_{\text{shoulder}} \times \% \text{ of daily generation met by shoulder gen.}) \\ & + (\text{LRMC}_{\text{peak}} \times \% \text{ of daily generation met by peak gen.}) \end{aligned}$$

Calculating the daily costs of RE without ES scenario

To assess the cost savings of including RE in the electricity grid, the model determines the optimal amount of RE capacity to install. The model assumes that all electricity demand that is not met by RE is met by the existing conventional generation units. In addition, given that the RE capacity is being added to an existing system without backup capacity, the model assumes that RE capacity cannot exceed 15 percent of electricity demand without compromising grid stability.

The model is set up to select the optimal amount of RE capacity in order to minimize the cost of meeting the daily load. If the LRMC of RE is lower than the avoided cost of conventional generation in a given hour, the model selects the optimal amount of RE by maximizing the following function up to 15 percent of electricity demand for a given hour:

$$\text{Net benefit of RE per day} = \sum_{i=1}^{24} [\text{Supply}_{\text{RE},i} \times (\text{LRMC}_{\text{RE}} - \text{Avoided cost}_i)]$$

Where:

$Supply_{RE,i}$ is the supply of RE for hour i , and corresponds to the lower of the total amount of electricity that the panel generates during hour i or electricity demand during that hour,

$Avoided\ cost_i$ is the short-run marginal cost (SRMC) of conventional generation avoided thanks to RE. The avoided cost of generation will be different from hour to hour depending on the mixture of base load, shoulder, and peak generation capacity that the grid uses to meet electricity demand, and

$LRMC_{RE}$ is the LRMC of RE (utility scale solar or wind, as shown in Table 4.3).

To calculate average daily costs of meeting the daily load profile after adding RE, the model subtracts the net benefit of RE per day from the cost per day calculated in the BAU scenario.

Calculating the daily costs of the RE and ES scenario

To assess the cost savings of including RE with ES in the electricity grid, the model determines the optimal amount of RE and ES capacity to install. The model assumes that all electricity demand that is not met by RE or ES is met by the existing conventional generation technologies. In addition, given that the RE backed up by ES capacity will not destabilize the grid, the model assumes that RE capacity can meet up to 15 percent of electricity demand plus the capacity of the ES installation, without compromising grid stability.

The model is set up to select the optimal amount of RE and ES capacity in order to minimize the cost of meeting the daily load. If the LCOES presented in Section 2.3 is lower than the avoided cost of conventional generation in a given hour, then the model will select the optimal amount of RE and ES by maximizing the net benefit of the following function without allowing the supply of RE to exceed 15 percent of electricity demand plus the size of the ES installation in a given hour:

Net benefit per day

$$= \sum_{i=1}^{24} [Supply_{RE,i} \times (LRMC_{RE} - Avoided\ cost_{RE,i}) + Supply_{Storage} \times (LCOES_i - Avoided\ cost_{ES,i})]$$

Where:

$Supply_{RE,i}$ is the amount of RE generation supplied directly to the grid,

$LRMC_{RE}$ is the LRMC of the RE used by the grid,

$Avoided\ cost_{RE,i}$ is the avoided cost is the short run marginal cost of conventional generation (SRMC),

$Supply_{Storage}$ is the amount of excess solar RE stored in the ES (net of storage losses) discharged to the electricity grid,

$LCOES_i$ is the levelized cost of energy discharged from the ES installation, and

$Avoided\ cost_{ES,i}$ is the LRMC of conventional generation. The model assumes that ES should receive a credit for the cost of capacity. This is because ES can be discharged reliably at any time.

To calculate average daily costs of meeting the daily load profile after adding RE with ES to the electricity generation matrix, the model subtracts the net benefit of RE with ES per day from the cost per day calculated in the BAU scenario. In addition, the model compares the net benefit of adding the optimized amount of RE with ES per day to the net benefit of adding the optimized amount of RE per day to ensure that combining ES with RE results in a larger benefit than using RE alone.

4.1.2 Calculating the daily reduction of conventional generation and carbon dioxide emissions

For the RE without ES and RE with ES scenario in each case study, the model calculates the increase in the share of renewable energy in total generation and the reduction in tons of carbon dioxide emissions. The model assumes that without RE or ES, all electricity demand is met by conventional generation. Therefore, the entirety of $Supply_{RE}$ and $Supply_{ES}$ replaces conventional generation. As a result, the daily increase in the share of RE in total generation is equal to the amount of electricity provided by RE in the RE without ES scenario, and RE and ES in the RE with ES scenario, divided by total generation. Because RE replaces all conventional generation, conventional generation is reduced by the same amount by which RE is increased.

Similarly, to calculate the daily reduction in carbon dioxide emissions the model assumes that, without RE or ES, all electricity demand is met by conventional generation, which emits carbon dioxide at the rate of the emission factor for the electricity sector in each case study country. For the small off-grid town and small island country the model uses an emission factor of $0.9\text{tCO}_2\text{e/MWh}$, based on Barbados's electricity mix (applicable also for an off-grid town given the prevalence of diesel). For the large interconnected country the model uses Mexico's emission factor of $0.6\text{tCO}_2\text{e/MWh}$ (Energy Information Agency). To determine the reduction in tons of carbon dioxide emissions, the model multiplies $\text{Supply}_{\text{RE}}$ and $\text{Supply}_{\text{ES}}$ for each scenario in each case study by the emission factor for the electricity sector in each case study country. The result is the daily reduction in tons of carbon dioxide emissions.

4.1.3 Assumptions

To develop each scenario of the three case studies the model makes assumptions about the avoided cost of generation, the cost of RE, and the cost of ES.

Assumptions for Avoided Cost of Generation

Under BAU , existing conventional generation is used for supplying all electricity (Table 4.2).

Table 4.2: Avoided Cost of Conventional Generation for Each Case Study

	Small Off-Grid Town*	Small Island Country**			Large Inter-connected Country***		
Generation Type	Base/Shoulder/Peak	Base	Shoulder	Peak	Base	Base/Shoulder	Peak
Technology	Small Diesel	Low Speed Diesel	Medium Speed Diesel	Gas Turbine	Hydro	Closed Cycle Gas Turbine	Open Cycle Gas Turb.
Capital cost (USc/kWh)	0.4	1.30	1.48	1.06	8.34	1.96	6.89
Fixed O&M cost (USc/kWh)	0.3	0.57	1.15	0.04	0.50	0.41	0.96
Variable O&M cost (USc/kWh)	5.6	0.96	0.82	0.62			
Fuel cost (USc/kWh)	29.6	14.75	13.91	18.59	-	5.52	8.21
Major maint. cost (USc/kWh)	0.08	0.06	0.12	0.00	-	-	-
Total LRMC (USc/kWh)	36.0	17.6	17.4	20.3	8.8	7.9	16.1

Source: *ANGLEC, 2012; **BLPC, 2012; ***World Bank. “Low-Carbon Development for Mexico”, 2010.

The cost of fuel underlying the above calculations is US\$4 per gallon, a reasonable estimate that for most Caribbean utilities corresponds to oil prices that medium term futures contracts are currently trading at (CME, 2012). The cost of natural gas used in the study referenced in Table 4.2 for Mexico is US\$7.85 per gigajoule (World Bank, 2010), which roughly corresponds to the same figure per million BTU (1 million BTU equals 1.055 GJ)—this is a very generous assumption under current market conditions, given that long-term (2020) natural gas futures as of end-2012 are trading at US\$5.7 per million BTU (CME, 2012). As explained below, a high cost of natural gas would be required to make RE with ES viable in the case of the large inter-connected country; using current prices or even the higher ones of long-term natural gas futures, RE with ES would not be economically viable.

Assumptions for Renewable Energy

For both the RE without ES and RE with ES scenarios of the small off-grid town, the model uses utility scale solar PV for the LRMC of RE; for the small island country and large inter-connected country, the model uses utility scale solar PV or utility scale wind energy for the LRMCs of RE. Solar PV and wind energy technologies are chosen because their intermittent resources are widely available in LAC. Table 4.3 below presents the assumptions used for calculating the LRMC of the RE systems in all three case studies.

Table 4.3: Characteristics and Costs of Utility Scale RE Installations

	Unit	Solar PV (2MW monocrystalline, fixed)	Wind (850kW)	Wind (850kW) in Oaxaca for large inter-connected country
Unit capital cost	<i>US\$/kW</i>	3,000.0	1,800.0	1,800.0
O&M costs per year	<i>US\$/kW/yr</i>	60.0	50.0	50.0
Lifetime	<i>Years</i>	20.0	20.0	20.0
Capacity Factor	<i>%</i>	23%	30%	40%
Output per kW capacity per year*	<i>kWh/kW/yr</i>	2,014	2,628	3,504
Capital cost recovery factor per kWh	<i>US\$/kWh</i>	0.17	0.08	0.05
O&M cost per kWh	<i>US\$/kWh</i>	0.03	0.02	0.01
LRMC	<i>US\$/kWh</i>	0.20	0.10	0.07

*Assuming a discount rate of 10 percent per annum

Assumptions for energy storage

In the RE with ES scenario of the small off-grid town and the small island country, the model uses lead-acid battery storage for the fixed costs of ES. Lead-acid battery ES is selected as the ES technology for these cases, because:

(i) It has a capacity range that can accommodate storing amounts of energy appropriate for small off-grid towns and small island countries

(ii) It has a lower capital cost than Li-ion batteries and flow batteries

(iii) It has proven to be a viable option, based on experience with operating projects in the LAC region.

In the large inter-connected country, the model uses PHS for the fixed costs of ES. PHS storage is selected as the ES technology for this case, because:

(i) It has a capacity range that can accommodate storing large amounts of energy appropriate for large inter-connected countries

(ii) It has a lower capital cost than NaS batteries and less restrictive siting than CAES

(iii) It has proven to be a viable option based on commercially operating projects globally.

Table 4.4 below summarizes the key characteristics and cost assumptions for lead-acid battery storage and PHS.

Table 4.4: Costs and Features of ES Systems

	Unit	Lead-Acid Storage	Pumped Hydro Storage
Unit capital cost/capacity	<i>US\$/kWh</i>	583.0	175.0
O&M costs per year	<i>US\$/kW/yr</i>	30.0	5.0
Lifetime	<i>Years</i>	12.3	40.0
Cycles	<i>Number</i>	4,500	14,600
Output per kWh capacity	<i>kWh</i>	4,500.0	14,600.0
Capital cost recovery factor per kWh	<i>US\$/kWh</i>	0.23	0.05
O&M cost per kWh	<i>US\$/kWh</i>	0.08	0.01
Fixed Costs	<i>US\$/kWh</i>	0.31	0.06

*Assuming a discount rate of 10 percent per annum

Source: IRENA, 2012

4.2 Three Case Studies for ES with RE in LAC

The three case studies suggest that optimizing RE will reduce the daily costs of meeting electricity demand, conventional energy generation, and carbon dioxide emissions under all three case studies. Furthermore, they show that in the small off-grid town and the small island country combining ES with RE will increase the share of RE in total generation. Table 4.5 summarizes the benefits of RE without ES and RE with ES for all three case studies.

Table 4.5: Impact of RE and RE with ES Scenarios for Case Studies

Indicator	Unit	Small Off-Grid Town		Small Island Country		Large Inter-Connected Country	
		RE w/o ES	RE with ES	RE w/o ES	RE with ES	RE w/o ES	RE with ES
Increase in Share of RE in Total Generation	%	6	49	11	50	7	7
Cost Reduction	%	3	17	5	15	2	2
CO ₂ Reductions	%	6	49	11	50	7	7
RE Relative to Peak Demand	%	23	181	33	130	14	14

As shown in the table, combining ES with RE can increase the share of RE in total generation significantly if it is economically viable. Further, there is a one to one relationship between increase in share of RE in total generation and reduction in carbon dioxide emissions. Finally, where adding ES is economically viable, the optimized RE with ES scenario recommends levels of RE above peak demand. This means that the model recommends taking advantage of the benefit of backup services as well as energy management services by using large amounts of RE to produce quantities of electricity above what could be demanded at any time, so that it can be discharged at a later time when intermittent resources are not available.

4.2.1 Small off-grid town: Colombia

In the small off-grid town case study, there are significant benefits to combining RE with ES due to the high avoided cost of generation in small off-grid towns. Therefore, when RE with ES removes the 15 percent constraint on RE supply by adding backup capacity and adds the ability to store lower-cost RE to discharge later through energy management, the model calculates a significant increase in the share of RE in total generation.

RE without ES provides limited benefits

Under the RE with ES scenario, the model determines that 327kW is the optimal amount of solar PV capacity that should be integrated in the electric grid. This provides a daily net benefit of US\$627 in avoided generation costs for a daily cost of US\$355 to pay for the solar PV. The result is a net benefit of US\$273. In addition, optimizing RE reduces carbon dioxide emissions by 1.5 tons daily. The figure below shows the impact on the daily load profile of adding RE.

Figure 4.2: Impact of Optimizing RE in a Small Off-Grid Town

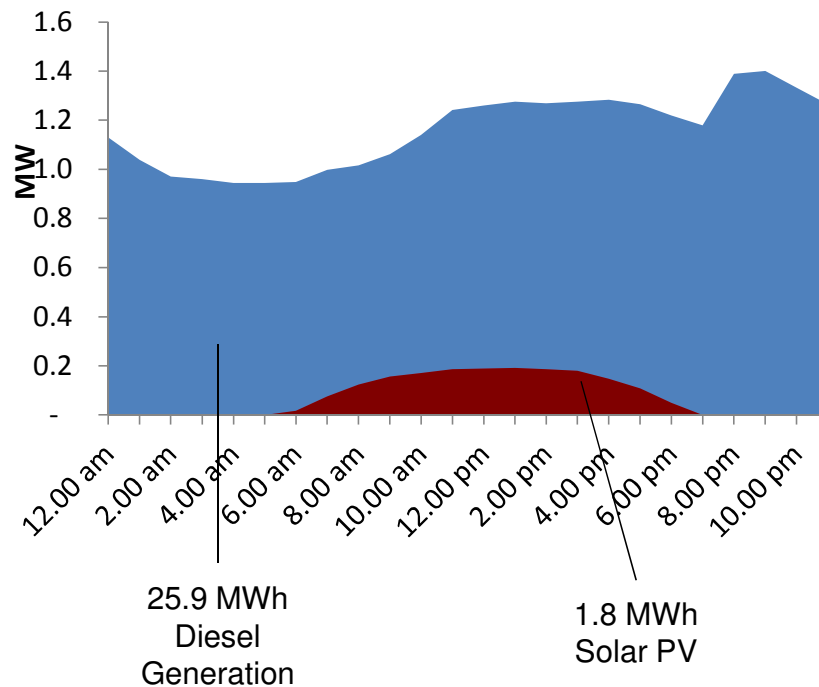

Source: Own calculations

The figure above shows how solar PV is constrained by the inability to exceed 15 percent of demand at any given time. As a result, much of the potential benefit of lower-cost intermittent RE is unrealized.

RE with ES provides significant benefits

When RE is combined with ES in the small off-grid town scenario, the benefits of RE increase significantly. In the RE with ES scenario, the model determines that 2.53MW is the optimal amount of solar PV capacity that should be integrated in the electric grid. The model also determines that the electric grid should integrate a 969kWh lead-acid battery ES system. This provides a daily net benefit of US\$4,772 in avoided generation costs for a daily cost of US\$3,132 to pay for the RE with ES. The result is a net benefit of US\$1,640. The figure below shows the impact on the daily load profile of combining ES with RE.

Figure 4.3: Impact of Optimizing RE with ES in a Small Off-Grid Town

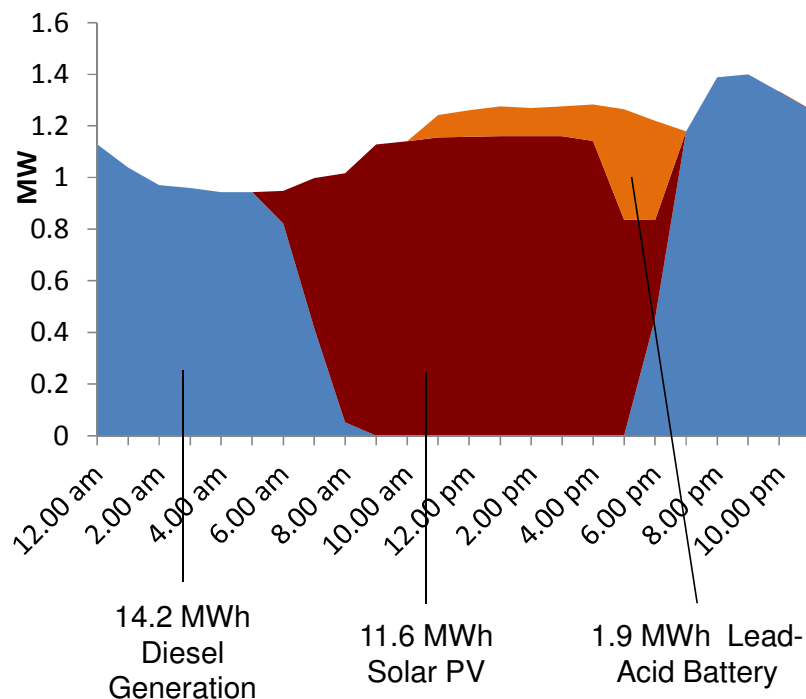

Source: Own calculations

In the figure above, ES increases the amount of RE used daily by 9.7MWh and reduces carbon dioxide emission by 11.89 tons daily. This result is not surprising—solar PV generation is more economical than diesel generation, so the amount of RE and ES capacity is selected to cover all of the electricity demanded throughout the day—when solar PVs intermittent resource is available—as well as charge the ES installation.

4.2.2 Small island country: Barbados

In the small island country case study, there are significant benefits to combining RE with ES due to the low cost of RE; high avoided cost of generation for peak demand; and moderately high avoided cost of shoulder and base load generation. However, this is only true for combining ES with utility scale wind. Combining utility scale wind with ES allows removing the constraint on intermittent RE supply (which we assume is equivalent to 15 percent of total demand), and generates significant benefits compared to using wind power without ES.

Combining ES with solar PV in the context of a small island country will only yield additional benefits if we assume a unit capital cost for solar PV of US\$1,700/kW—which represents an aggressive assumption—and a discount rate of 5 percent—which would be feasible if subsidized financing from institutions such as the IDB was available. Nevertheless, in light of the difficulties that Barbados has experienced in procuring utility scale wind, we examine a scenario that limits wind capacity to 10MW of total installed capacity, and that uses the aggressive cost and low discount rate assumptions for solar PV—to determine the potential benefits of using ES in combination with solar PV, if solar PV were economically viable.

RE without ES provides limited benefits

Under the RE without ES scenario, the model determines that 5.35MW of wind power is the optimal amount of renewable energy capacity that should be integrated in the electric grid. This provides a daily net benefit of US\$61,332 in avoided generation costs, for a daily cost of US\$36,905 to pay for the wind energy. The result is a net benefit of US\$24,427. In addition, optimizing RE reduces carbon dioxide emissions by 324.64

tons daily. The figure below shows how wind power and conventional generation are used for covering the system's daily load.

Figure 4.4: Impact of Optimizing RE in a Small Island Country

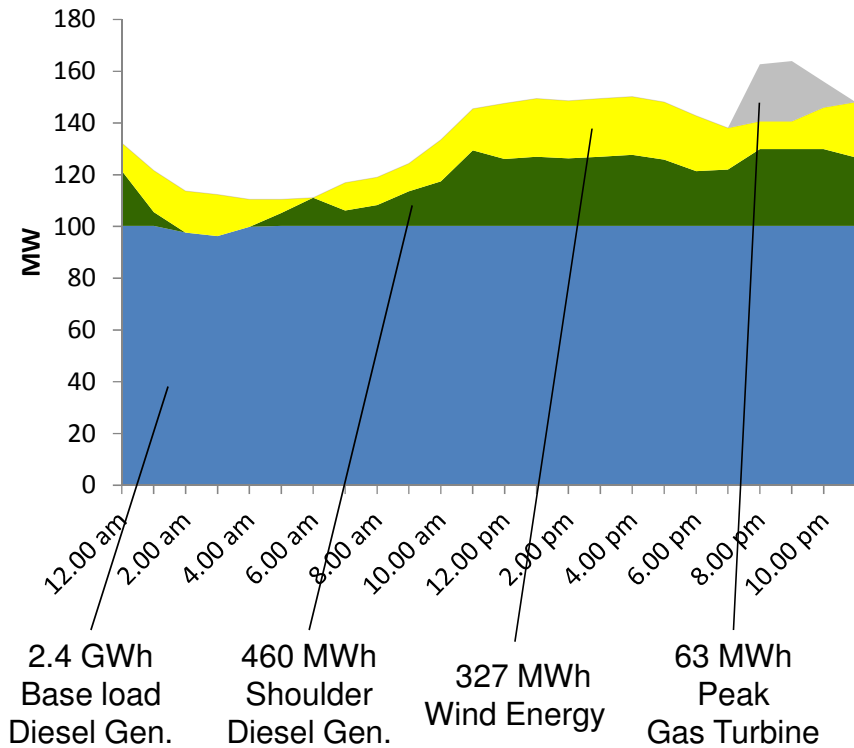

Source: Own calculations

In the figure above, utility scale wind power is displacing some peak generation, but is constrained by the inability to exceed 15 percent of demand at any given time. Therefore, there are significant unrealized benefits in this scenario.

When assuming a capital cost for solar PV of US\$1,700 per kW and limiting the amount of wind power capacity to a maximum of 10MW, the model determines that the optimal amount of solar PV capacity that should be integrated in the electric grid is 29.5MW. Figure 4.5 below shows how solar PV, wind power, and conventional generation are used for supply electricity throughout the day.

Figure 4.5: Impact of Optimizing RE in a Small Island Country (assuming viable solar PV)

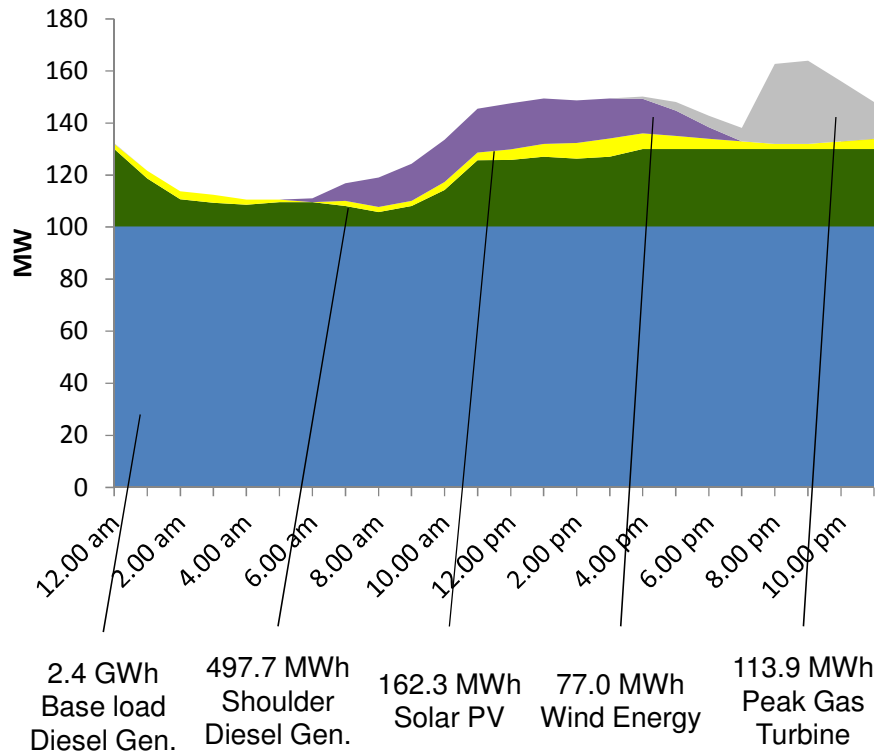

Source: Own calculations

The scenario presented above yields savings equivalent to US\$40,244 per day, and costs equivalent to US\$26,325 per day compared to the BAU scenario. The result is a net benefit of US\$13,920 per day and a reduction in carbon dioxide emissions of 209.41 tons per day, compared to the BAU scenario.

RE with ES provides significant benefits

In the RE with ES scenario, the model determines that 213.4MW is the optimal amount of utility scale wind capacity that should be integrated in the electric grid. The model also determines that the electric grid should integrate a 75.6MWh lead-acid battery ES system. This provides a daily net benefit of US\$254,087 in avoided generation costs for a daily cost of US\$176,858 to pay for the RE with ES. The result is a net benefit of US\$77,228. The figure below shows the impact on the daily load profile of combining ES with RE.

Figure 4.6: Impact of Optimizing RE with ES in a Small Island Country

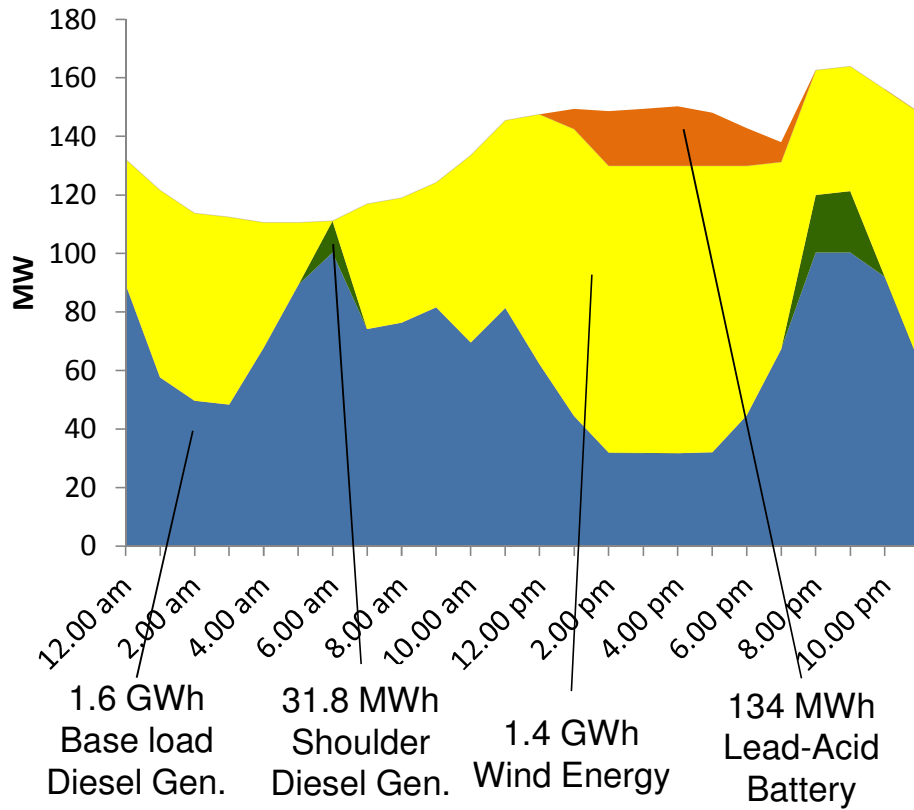

Source: Own calculations

In the figure above, ES increases the amount of RE used daily by 1GWh and reduces carbon dioxide emissions by 1,423 tons daily. The figure shows that by adding ES, all of the expensive peak generation is displaced by lower-cost RE and ES. In addition, a sizable amount of shoulder and base load capacity is replaced by lower-cost RE; however, as the figure shows, at a certain point it becomes too expensive to pay for more ES to back up RE replacing shoulder and base load capacity. For that reason, the model does not determine that lower-cost RE should replace all conventional generation.

In the RE with ES scenario that constrains the amount of wind power capacity to 10MW and uses aggressive assumptions for solar PV, the model determines that given the availability of ES, the optimal amount of solar PV capacity that should be integrated in the electric grid is 49.5MW (in addition to 10MW of wind power capacity). The model also determines that the electric grid should integrate a 5.4MWh lead-acid battery ES

system. The figure below shows the impact on the daily load profile of combining ES with RE.

Figure 4.7: Impact of Optimizing RE with ES in a Small Island Country (assuming viable solar PV)

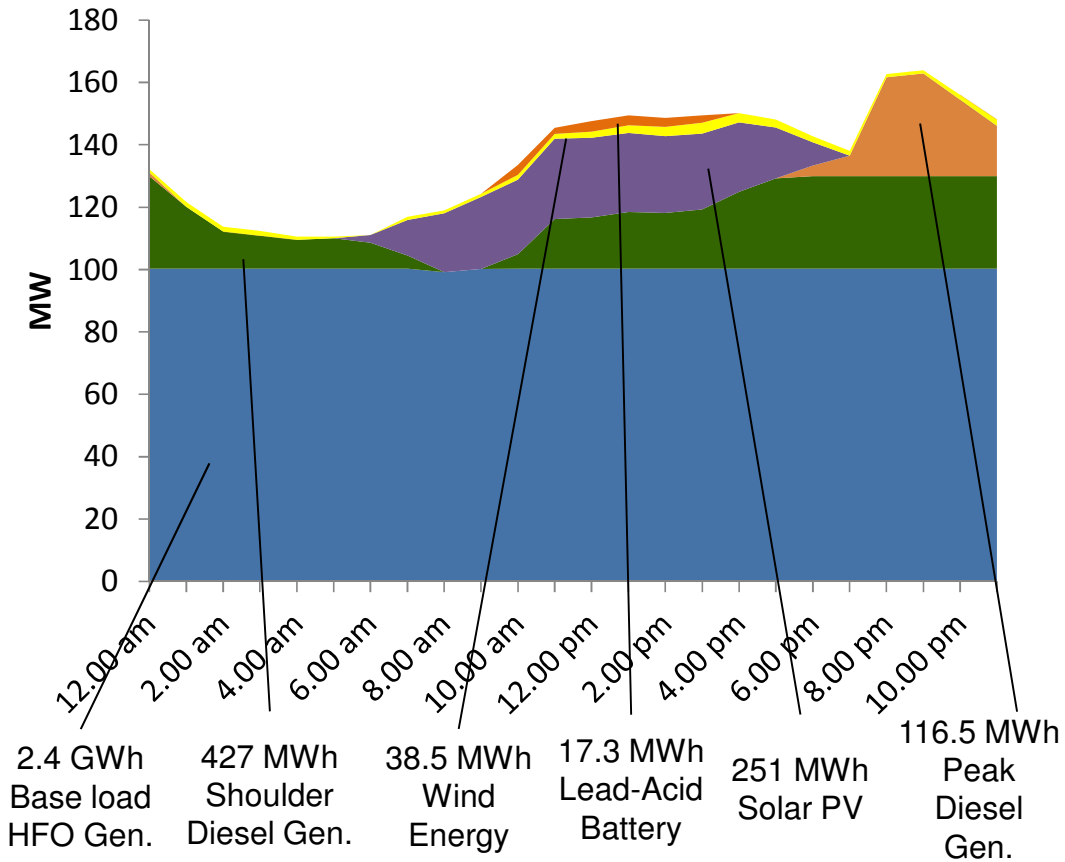

Source: Own calculations

In the scenario illustrated above, ES increases the amount of RE used by 90MWh per day and reduces carbon dioxide emissions by 60 tons per day, compared to the RE only scenario with solar PV. The figure above shows that given the assumptions used, using ES in combination with solar PV allows for solar PV to displace a large portion of peak generation and a portion of shoulder generation. This results in savings amounting

to US\$49,971 per day, for a cost of ES and RE of US\$38,163 per day—thereby amounting to a net benefit of US\$11,808 per day compared to the RE only scenario.

4.2.3 Large inter-connected country: Mexico

In the large inter-connected country case study, there are benefits to optimizing RE. Optimizing RE with ES does not prove economically viable—and not close to being so.

The model recommends optimizing RE because the LRMC of utility scale wind energy (using high capacity factors from Oaxaca) is below the SRMC of peak generation in Mexico. For this reason, the model determines that wind energy should meet some of Mexico’s demand for peak generation—unsurprisingly, given that it is what actually has been happening for several years.

However, the LCOES of providing additional wind capacity to meet a larger share of peak demand by adding PHS is above the avoided cost of conventional generation for all types of generation—even using the very high assumption of natural gas cost (US\$7.85 per gigajoule), although in this case the difference would be of just US\$0.01 per kWh.

RE without ES provides some benefits

Under the RE without ES scenario, the model determines that 7.4GW is the optimal capacity of wind energy capacity that should be integrated in the electric grid. This provides an average daily net benefit of US\$5,371,451 in avoided generation costs for a daily cost of US\$4,326,680 to pay for the RE. The result is a net benefit of US\$1,044,771. In addition, optimizing RE reduces carbon dioxide emissions by 45,116 tons daily. The figure below shows the impact on the daily load profile of adding RE.

Figure 4.8: Impact of Optimizing RE in a Small Island Country

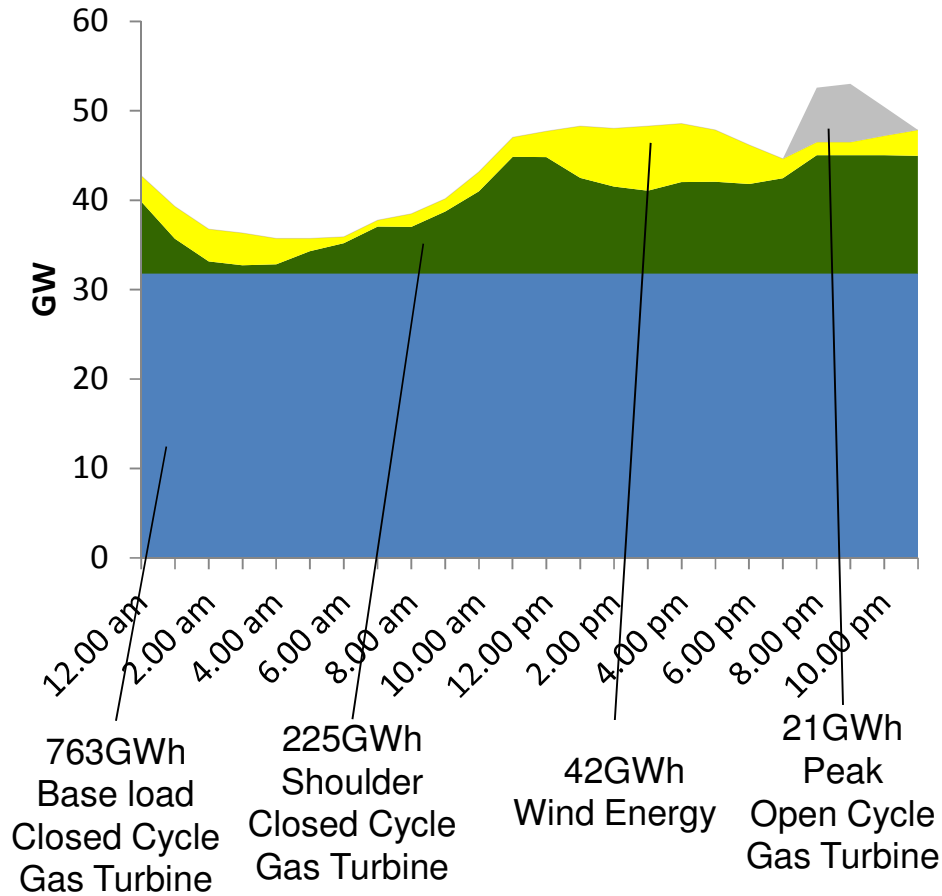

Source: Own calculations

The figure above shows how utility scale wind is displacing some peak generation. In addition, wind energy meets some shoulder capacity generation needs; during these times, wind energy operates at a loss, but the loss is offset by benefits during peak times. The figure also shows that there is a significant amount of expensive peak generation that could potentially be met by wind energy if it became economically viable.

RE with ES is not economically viable to increase RE in a large inter-connected country

In the large inter-connected scenario using the very high assumption for natural gas (US\$7.5 per million BTU or US\$7.85 per gigajoule), the LRMC of peak generation is US\$0.16 per kWh; the LCOES of utility scale wind combined with PHS is US\$0.17 per

kWh. As a result, the cost of providing peak generation capacity from PHS is just US\$0.01 below economic viability even assuming natural gas prices, higher than those of long-term futures (US\$5.7 per million BTU for 2020). Therefore, for RE with ES to be economically viable in large inter-connected countries, the cost of conventional peak generation would have to rise to about US\$0.17 per kWh (which could happen with natural gas prices of almost US\$8 per million BTU).

The cost of peak generation is expected to remain at lower values for the foreseeable future. Peak generation in Mexico is provided by open cycle gas turbines, powered by natural gas. The price of natural gas has fallen dramatically in recent years—from as high as US\$14 per million BTU to US\$4 per million BTU—mainly due to opening of vast shale natural gas reserves in North America; and it is expected to remain relatively stable, only to rise slowly to around US\$5.7 per million BTU by 2020 (CME Group). Therefore, absent sufficient increases in the price of natural gas, either the cost of ES or the cost of RE would have to fall significantly for ES to become economically viable.

If natural gas prices did rise to the level of about US\$7.5 per million BTU (US\$7.85 per gigajoule), RE with ES would be very close to being economically viable—almost within a margin of error, as shown in the figures below for the costs of PHS and wind energy.

Figure 4.9: Breakeven Curve for PHS Fixed Costs in Large Inter-Connected Country

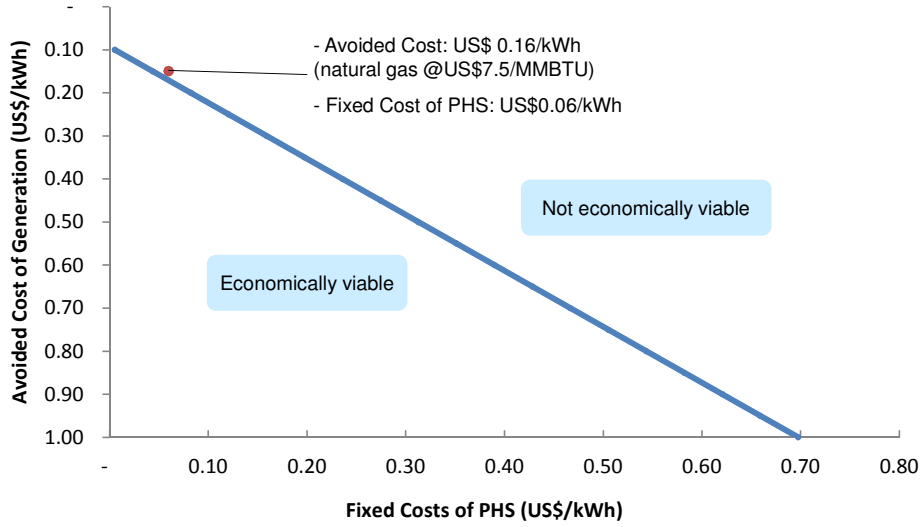

Since PHS is a very mature technology, its fixed costs are not likely to fall in the foreseeable future (Black & Veatch); further reductions in the cost of utility scale wind energy would be more likely.

Figure 4.10: Breakeven Curve for RE with PHS in Large Inter-Connected Country

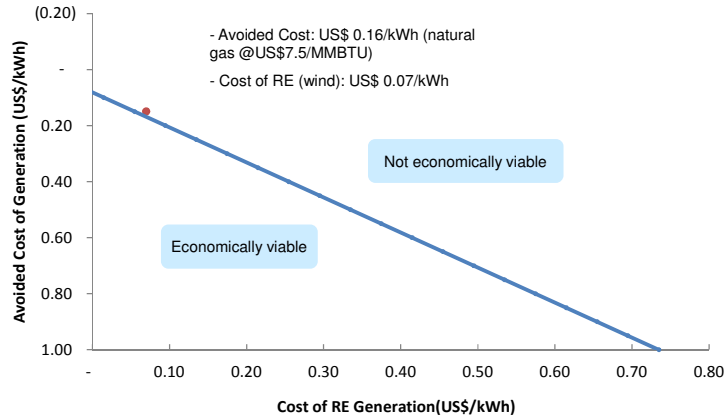

If economically viable, RE with ES would increase RE

The benefits of RE would of course increase if much higher prices of natural gas and slightly lower RE costs made combining RE with ES economically viable. Assuming that the cost of RE fell to US\$0.06 per kWh (which could happen if unit costs of wind

were at US\$1,540, instead of—as assumed—US\$1,800 per kW installed) and that natural gas prices were about US\$7.5 per million BTU, 16.5GW would be the optimal amount of utility scale wind capacity that should be integrated in the electric grid, and it should be combined with a 19.2GWh PHS ES system. This would provide a daily net benefit of US\$13,652,427 in avoided generation costs, for a daily cost of US\$11,394,912 to pay for the RE with ES. The result would be a net benefit of US\$2,257,514. The resulting dispatching is shown in the figure below.

Figure 4.11: Impact of Optimizing RE with ES in a Large Inter-connected Country

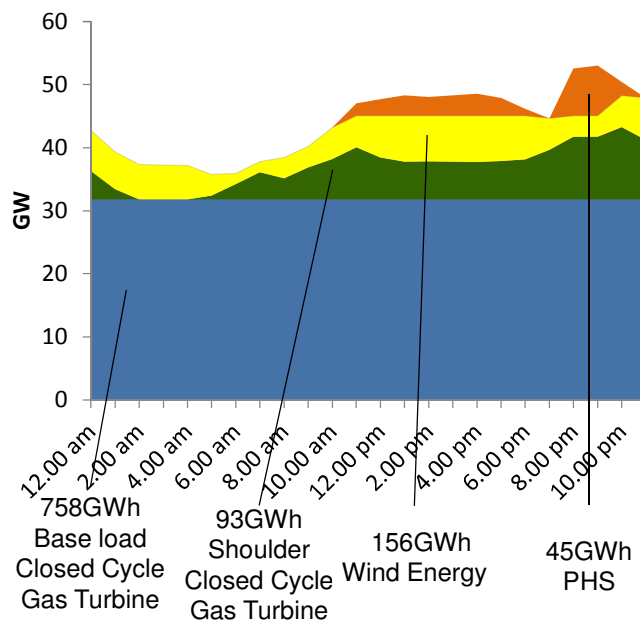

Source: Own calculations

The ES system would increase the amount of RE used daily by 114GWh, and increase the carbon dioxide emission reductions to 97,244 tons daily. By adding ES, all of the expensive peak generation would be displaced by lower-cost RE and ES. Similar to the RE without ES scenario, RE with ES would also provide some shoulder capacity at a loss; however, gains from replacing peak demand would offset losses. Wind energy cannot technically replace base load power, because combined cycle gas turbines are a must-run technology—meaning they cannot easily be turned on and off.

4.3 Applying Case Studies to Estimate Potential Benefits of Energy Storage in LAC

The model scales up the results of our case studies by applying potential impacts to communities, countries, and regions that approximate the conditions considered in each case study. As summarized in Section **Error! Reference source not found.**, scaling up the results of our analysis to determine the potential impacts in the LAC region as a whole reveals large potential benefits of combining RE with ES in the small off-grid towns and small island countries of LAC. Combining RE with ES is not viable in the Mexico case study, even considering Oaxaca’s high wind energy capacity factors and assuming prices of natural gas higher than those of today. Therefore, it is not likely that combining RE with ES will be economically viable in the LAC region’s large interconnected grids in the near future, and no scale-up analysis is done for large interconnected grids in the LAC region.

4.3.1 Regional scale-up of small off-grid towns

To determine the potential benefits of the scale-up in small off-grid towns, the model determines the population of individuals in LAC living in small off-grid towns. Then, it applies the benefits of using RE with ES shown in our case study proportionally to the population living in off-grid small towns as a whole.

The model determines the population in LAC living in small off-grid towns by comparing the number of people living without power in Colombia as reported by the International Energy Agency (IEA) to the number of people without electricity living in small off-grid towns in Colombia, as reported by the Instituto de Planificación y Promoción de Soluciones Energéticas para las Zonas No Interconectadas. This provides the model with a rough proportion of how many people living in LAC without power as reported by the IEA live in small off-grid towns. Applying that proportion to the IEA’s figures of population without power for each LAC country provides an estimate of how many people live in small off-grid towns without power in LAC.

Next, the model compares the number of people in Colombia living in small off-grid towns in Colombia with power, to those living in small off-grid town without power, to determine the proportion of people in LAC that live in small off-grid towns without

power to those who live in small off-grid towns with power. Applying that proportion to the number of people living in small off-grid towns without power in LAC provides an estimate of how many people live in small off-grid towns with power in LAC.

Finally, the model adds the population living in small off-grid towns with and without power to reach a rough estimate of 30 million people living in small off-grid towns in LAC with and without power. As a result, the benefits of the small off-grid case study are scaled to an electricity market for 30 million small off-grid consumers.

4.3.2 Regional scale-up of small island countries

The model applies the percentage reductions for carbon dioxide emissions and costs as well as the percentage increase for share of RE in total generation in the small island country case study to each small island country to the LAC region. To determine the potential benefits for small island countries in LAC, the model considers the peak demand, annual electricity sales, and annual carbon dioxide emissions of each small island country in LAC, as reported by their local utilities. Finally, the model sums the results for each country to calculate the potential regional benefits for the LAC region.

The regional scale-up of small island countries in LAC includes Antigua and Barbuda, Barbados, Dominica, Grenada, St. Kitts and Nevis, St. Lucia, and St. Vincent and the Grenadines. These are not the only islands in the LAC region; however, islands that are part of other larger countries are dealt with as part of the small off-grid town example; and large island countries, such as Jamaica and Cuba, each have a peak demand that is well beyond the scope of the small island country case study.

5 Policies for Realizing Benefits of Energy Storage with Renewables in LAC

There are concrete actions that can take place to realize the LAC region's potential of combining RE with ES. That include disseminating information; promoting policy and regulatory reform; and providing financing among others. To be effective, these actions need to be tailored to suit the electricity markets. Some electricity markets—including those of most small off-grid towns—are vertically integrated, and publicly operated and planned ('publicly planned'). Other electricity markets—as is the case for numerous small island countries—are vertically integrated, privately operated and planned, and overseen by a public regulator ('privately planned'). Finally, in many large inter-connected electricity markets private providers respond to cost and price signals ('wholesale markets'). There are various actions that policy makers can take in each of these types of markets.

Organizing conferences to learn and share ideas about ES technologies would constitute another effective way of providing information to various stakeholders in different types of markets—including public sector planners, private sector planners, and regulators. The conferences could cover basic information about ES technologies for all participants, while also offering breakout sections relevant to different types of markets—such as, for instance, sessions for discussing the integration of ES in power sector planning for publicly planned markets; best practices for ensuring that private utilities consider both RE and ES in their investment plans; and the proper valuation of ES investments for wholesale electricity markets. The conference sessions could also feature success stories relevant to each type of power market.

Both think tanks and MDBs could offer technical assistance for publicly planned and privately planned electricity markets. For instance, the IDB could help develop the capacity of public planners to consider and evaluate ES combined with RE in their investment plans. In privately planned electricity markets, the IDB could work with

regulators to assess investment plans that include projects combining ES with RE. Finally, the IDB could support educational and training programs on the appropriate operation and maintenance of ES technologies—this will be crucial to ensuring that ES projects implemented are successful, particularly in small, off-grid communities.

The IDB as well as other International organizations could encourage policy and regulatory reform in different types of electricity markets to align incentives for integrating economically viable ES with RE. In publicly planned markets, the IDB could promote official government policy that encourages planners to consider RE with ES in expansion plans. In privately planned electricity markets, the IDB could promote regulation that requires private utilities to demonstrate that they consider RE with ES in their least-cost expansion plans and—if it is economically viable—that they include RE combined with ES in their plans, and are able to recover those investments through tariffs. In wholesale electricity markets, the IDB could promote regulation that fairly compensates RE with ES—this means ensuring that ES options that can provide power reliably are eligible to receive a full capacity credit, and that RE options that become reliable when combined with ES also receive a full capacity credit, to achieve full technology neutrality.

There are various financing options that the IDB could offer to advance good investment in ES and RE in LAC. In publicly and privately planned electricity markets, the IDB could finance feasibility studies that determine which ES options are most appropriate for a country, and assess the viability of possible investments in such options. In addition, the IDB could provide concessional financing for the first investments in economically viable projects combining ES with RE. Financing feasibility studies and providing concessional financing would help overcome the initial wariness of stakeholders regarding new or unfamiliar technologies.

In wholesale electricity markets, the IDB should continue to monitor the cost of ES technologies and potential viability of projects combining ES with RE. When the conditions are right for such projects to become economically viable, the IDB could finance feasibility studies that demonstrate the viability of these projects—including, in particular, feasibility studies for PHS (given that PHS costs can vary significantly

depending on the site)—which could then be provided to qualified bidders for developing projects.

The IDB could also consider funding carbon pricing schemes and risk sharing facilities that increase the attractiveness of investments in projects combining RE with ES in publicly or privately planned systems, and wholesale markets. Assuming an emission factor of 0.6tCO₂ per MWh (as Mexico's), a carbon pricing scheme would require about US\$16.7 per ton of CO₂ for each US cent of gap between RE with ES and conventional generation.

Appendix A: Energy Storage Technologies

This Appendix describes each energy storage technology.

A.1 Lead-Acid Batteries

Lead-acid batteries are the most common ES technology. They have low capital costs, reasonable roundtrip efficiency, and are well-understood—therefore, easily serviced. This makes them attractive technologies for use in small systems that do not have the technical capacity to service advanced ES technologies, or where cost minimization is an important factor. The drawback of lead-acid batteries is their short lifespan. Because of their shorter lifespan, lead-acid batteries have a higher cost (fixed cost per kWh) than NaS batteries or flow batteries.

Lead-acid batteries are commonly used in a wide range of applications in the commercial and industrial sectors. This includes more traditional uses of ES such as storing energy to start and light cars, power electric vehicles like golf carts or electric wheelchairs, and for emergency lighting. However, these lead-acid batteries typically do not tolerate very deep discharges. Deep cycle lead-acid batteries—batteries that can discharge a large amount of energy in one cycle without being significantly damaged—are most appropriate for ES (IRENA, 2012).

Functioning

Lead-acid batteries are defined by their use of lead plates to form the two electrodes of the battery. There are two types of configurations for lead-acid batteries: wet cell, and valve regulated (VRLA) batteries. A wet cell uses distilled water as part of its electrolyte, and the distilled water has to be replaced on a regular schedule (typically about twice a year). Wet cell batteries must also be oriented upright to prevent spilling electrolyte. VRLA batteries require less maintenance, and are less sensitive to non-upright orientations than wet cells. Finally, some lead-acid batteries use a gel as an electrolyte, which makes them less sensitive to non-upright orientations (IRENA, 2012). The figure below shows a schematic of how lead-acid batteries function.

Figure A.1: Schematic of Lead-Acid Battery

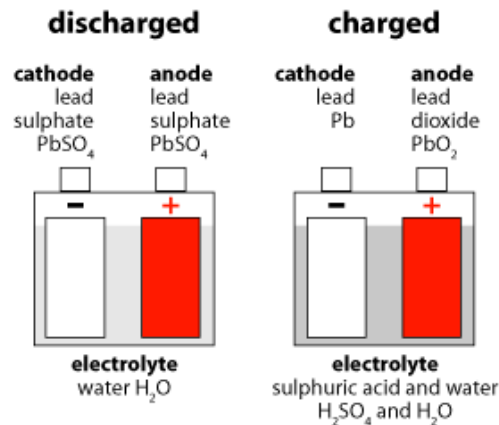

Source: Renewable Energy of Plum Hollow. "Glossary and Frequently Asked Questions." Accessed on 12/10/2012 at: <http://www.plumhollow.ca/go-wind/faq-alternative-energy>

Current state of development and perspectives

Lead-acid batteries are a mature and familiar technology; however, experimentation with size and chemical composition of the lead plates by various manufacturers continues to improve their duration and depth of discharge. Currently, discharging lead-acid batteries employs a chemical reaction that corrodes the electrodes at a faster rate than other electrochemical storage technologies—this explains the short lifespan.

In addition, new designs, such as dry cell batteries and ultra-batteries, are innovations on the traditional lead-acid battery.

Dry cell batteries are an innovation on a technology originally developed in the 1990s, which uses metal-coated fiber mesh as part of the battery. This type of battery has recently been installed in several large installations in Hawaii. In these installations, which range in size from 1.25MW to 15MW, the advanced dry cell batteries have been paired with wind and solar energy (DoE, 2012).

Ultra-batteries are hybrid ES devices that combine VRLA batteries with electrochemical capacitors (IRENA, 2012). Electrochemical capacitors store power physically between a high surface area carbon electrode and a liquid electrolyte.

Physically storing the power means that there is no chemical reaction taking place. This greatly extends the lifespan of the battery, because, as mentioned above, chemical reactions greatly reduce the life of batteries (Cantec Systems, 2012).

Most common ES applications

Since lead-acid batteries can be drawn upon quickly, they are appropriate for energy management and power quality regulation purposes, as well as for backing up power in small RE installations. Lead-acid batteries can also discharge for moderate periods of time; this makes them reasonably useful for transmission and distribution investment deferral. Lead-acid battery installations are generally too small for large conventional generation plants. They are ideal for systems where physical space is not a major concern, and low up-front costs are preferred.

A.2 Li-Ion Batteries

Lithium (Li)-ion batteries are smaller than lead-acid batteries, but they are more expensive. They also can be charged and discharged more reliably and can handle deeper discharges from their stated capacities without being damaged—giving them higher duration, efficiency, and lifespan. Despite their benefits, Li-ion batteries have the highest long run marginal cost (LRMC) of all the technically viable ES technologies (IRENA, 2012).

As a result, Li-ion batteries are only desirable as a higher end alternative to lead-acid batteries where reliability is prized and physical size is constrained. This explains why small electronic devices—such as mobile phones, handheld game systems, and laptops—typically use Li-ion batteries.

Functioning

Li-ion batteries function in a similar manner as lead-acid batteries. The electrodes are made of carbon and metal oxide. The lithium is in the form of a salt, placed in an organic solvent that forms the electrolyte. If the battery is discharging, the carbon is the negative electrode and the metal oxide is the positive electrode. The roles of the electrodes reverse when the battery is being charged. The figure below shows a schematic of how lithium-ion batteries function.

Figure A.2: Li-Ion Battery Schematic

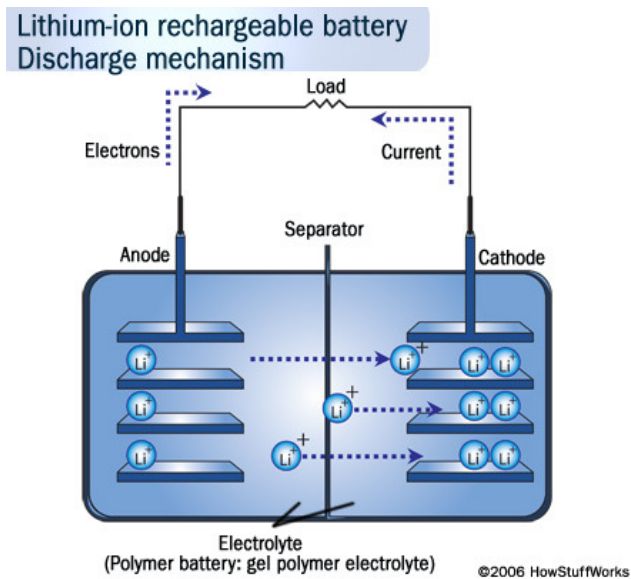

Source: Brain, M. “How Lithium-ion Batteries Work.” How Stuff Works. Accessed 10/15/2012 at:
<http://electronics.howstuffworks.com/everyday-tech/lithium-ion-battery1.htm>

Current state of development and perspectives

Li-ion technology has been steadily improving over the past decade as mobile devices have drawn more heavily on the technology. For small mobile applications, Li-ion may be considered a mature technology; however, in electrical grid applications, Li-ion is still developing. The most important development perspective is the addition of new Li-ion chemistries that can reduce costs, improve safety, and increase lifetime while maintaining the efficiency and compact size of Li-ion batteries (IRENA, 2012).

Most common ES applications

Li-ion batteries are very versatile. Similar to lead-acid batteries, they can be drawn upon quickly, making them appropriate for providing power management and backup power for renewable and conventional generation plants. They can also be used for power quality regulation and transmission and distribution deferral purposes. They also can discharge for longer periods of time than lead-acid batteries, and can therefore be more useful for energy management for small grids using RE.

Li-ion batteries are most appropriate for installations where physical size and weight need to be minimized. In addition, Li-ion batteries are more durable and have greater efficiency than lead-acid batteries, so they may be more attractive than lead-acid batteries wherever durability is a major concern.

A.3 Flow Batteries

Flow batteries have the highest capital costs of electrochemical storage options, and together with lead-acid batteries have the lowest efficiency. However, their high costs are compensated by their long lifespan. As a result, the cost per kilowatt hour (kWh) of flow batteries is lower than that of lead-acid batteries and Li-ion batteries.

Functioning

Flow batteries are comprised of electrolyte tanks and a cell stack. Unlike other electrochemical storage options, there are two electrolytes in a flow battery, one positive and one negative. The positive and negative electrolytes are delivered to the stack by pipes from a tank where the electrolyte is stored to cause the reaction that generates electricity.

The cell stack contains the two electrodes that house the anode and cathode. The electrolytes charge the two electrodes and an ion selective membrane uses the charge difference between the two electrodes to produce electricity.

A benefit of flow batteries is that the size of the cell stack roughly corresponds to the amount of power that the flow technology can supply or absorb at once, and the electrolyte volume roughly corresponds to the amount of energy that can be stored in the flow battery. This means that both the cell stack and the electrolyte can be sized to have storage that precisely meets the needs of the generation installation or grid (IRENA, 2012). The figure below shows a schematic of how flow batteries function.

Figure A.3: Flow Battery Schematic

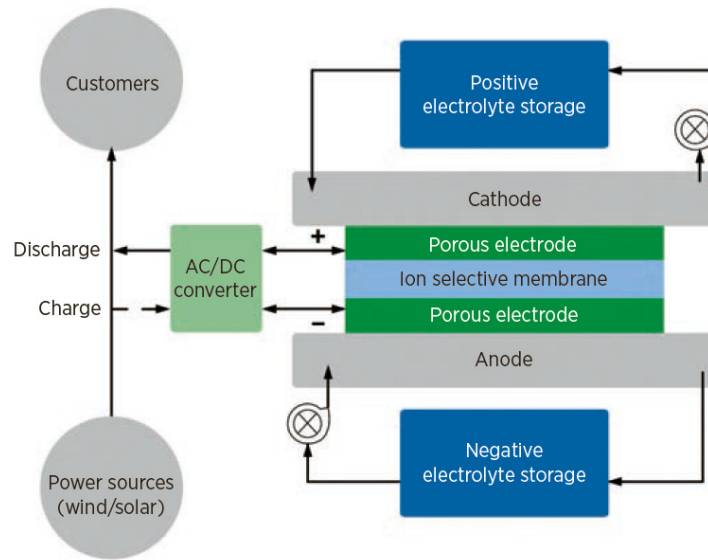

Source: IRENA, 2012

Current state of development and perspectives

There are two common types of flow battery chemistries: vanadium redox batteries (VRB) and zincbromine batteries (ZBB). VRB technology has more expensive cell stacks, but less-expensive electrolyte than ZBB. Additionally, the electrolyte of VRB flow batteries can potentially last longer than 100 years (IRENA, 2012).

One of the biggest challenges for flow batteries is their low energy density—they can store relatively small amounts of energy given their size. The cell stack is similar to the size of other electrochemical storage options; however, flow batteries require electrolyte tanks, piping, and pumps to hold and transport the electrolyte—all of which increases the size of the installation.

As a result, the most important potential developments in flow batteries involve reducing their size by developing more compact designs. In addition, manufacturers are experimenting with new chemistries that include iron-chromium (Fe/Cl) and zinc-chlorine (Zn/Cl). The new chemistries could improve power density, thereby improving the performance of flow batteries and reducing their size (IRENA, 2012).

Most common ES applications

Similar to lead-acid batteries and Li-ion batteries, flow batteries can be drawn upon quickly and are limited in capacity. This makes them appropriate for use in energy management, power quality regulation, and backup power in small RE systems. They also can discharge for moderate periods of time, meaning that they may be appropriate for transmission and distribution investment deferral purposes.

The added advantage of flow batteries is that their capacity can be sized exactly to the needs of the grid. This means that flow batteries are appropriate in systems that may need to increase their storage capacity quickly and easily. In general, ZBB is being marketed toward smaller systems, whereas VRB is being marketed to medium scale to large customers (Sandia, 2010).

A.4 NaS Batteries

Sodium-Sulfur (NaS) batteries are very commonly used for very large ES installations. Compared to lead-acid or Li-ion batteries, NaS batteries have the longest life and are typically used in installations larger than 100MW. Their large size helps defray the cost of operations and maintenance and the cost of capacity among the many individual units used to create the storage installation. As a result, their cost per unit of capacity is amongst the lowest of all the ES technologies (IRENA, 2012).

Functioning

NaS batteries work similar to lead-acid batteries and Li-ion batteries. For NaS batteries one electrode is made of sodium and the other is made of sulfur. Unlike lead-acid or Li-ion batteries, the sodium and sulfur are molten, and the electrolyte is a solid membrane between the anode and the cathode. Ions pass from the sodium to the sulfur, and vice versa, through a solid electrolyte membrane. The most widely used NaS batteries require high temperatures for the reaction that generates the electric current. In addition, the chemicals involved are highly corrosive (IRENA, 2012). This necessitates constant supervision to avoid fires or discharges of dangerous chemicals into the local environment. The figure below shows a schematic of how NaS batteries function.

Figure A.4: Schematic of NaS Battery

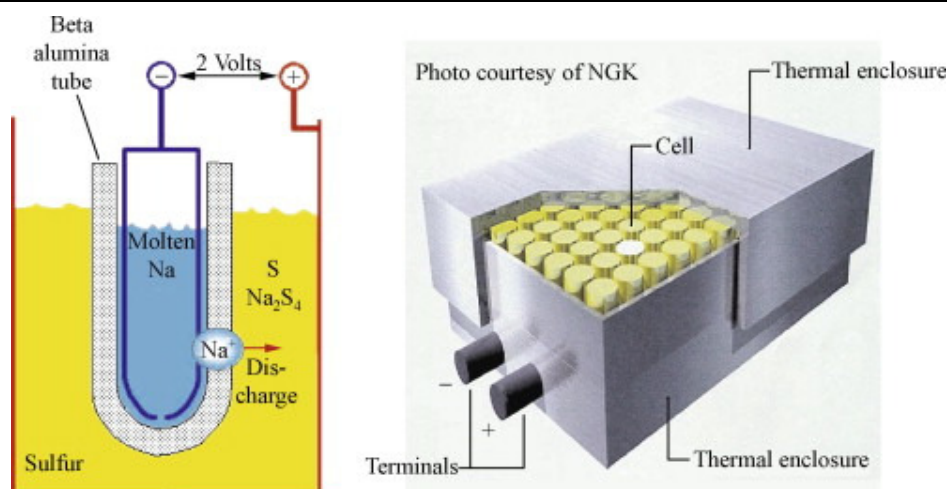

Source: Chen, H. et. al. "Progress in electrical energy storage system: A critical review" *Progress In Natural Science* 19(2009):3

Current state of development and perspectives

NaS batteries are a maturing technology that is being implemented in ES projects worldwide. The most promising development prospects are alternate NaS technologies that can operate at low temperatures and can produce more power for their size (IRENA, 2012).

Most common ES applications

The high heat and dangerous chemicals associated with NaS batteries make the technology suitable only for use in large scale RE applications—for example, large wind farms—where there is constant maintenance support. In these installations they can be used for energy management, power quality, and backup power. NaS batteries can also be used to provide power quality and backup services to large conventional generation plants connected to the grid (IRENA, 2012).

A.5 Pumped Hydro Storage

Pumped Hydro Storage (PHS) pumps water uphill with inexpensive, unused electricity, and then releases the water to flow through turbines to generate electricity

when needed. PHS has a relatively long history among ES technologies. System operators are familiar with the technology, and consider it reliable and useful. For this reason PHS is the only ES technology currently deployed on a gigawatt scale in the United States and worldwide. In the United States alone there are more 20GW of PHS deployed at over 40 sites. Installations can range in capacity from less than 50MW to 2,100MW (NREL, 2010).

PHS can offer very large amounts of storage and will last for the longest time of all ES options. The cost per kWh of PHS is amongst the lowest of all ES technologies—although capital costs may vary significantly depending on the site.

Functioning

PHS uses electricity generated during periods of low demand—which is generally lower cost than during peak demand—or excess electricity from intermittent RE sources, to pump water from a low elevation reservoir to a high elevation reservoir. During periods of peak demand, the water is released to flow back down to the lower reservoir, turning turbines to generate electricity, similar to conventional hydropower plants. This results in a lower average cost of generation for a given electricity system (Pew, 2009). PHS requires large reservoirs; therefore, it is not modular, and is highly site-specific (IRENA, 2012). The figure below shows a schematic of how PHS functions.

Figure A.5: Schematic of PHS

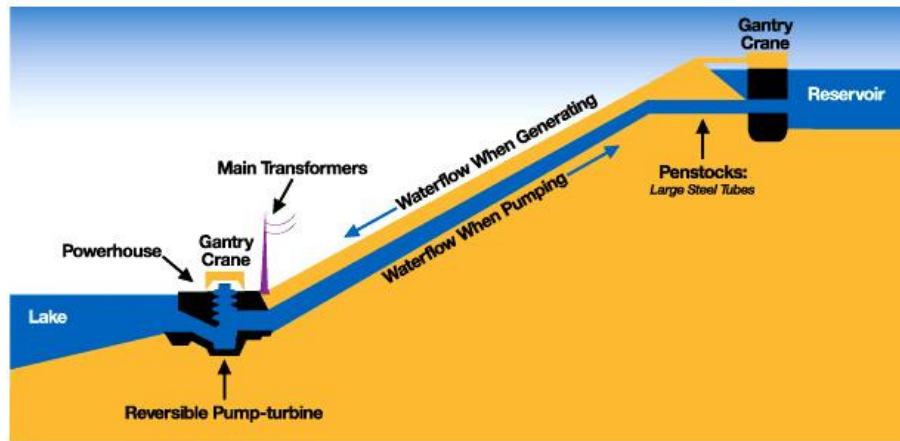

Source: Aurand, G. and Samuels G. “Hydroelectric Power.” University of Iowa Accessed 12/10/2012 at: <http://wiki.uiowa.edu/display/greenergy/Hydroelectric+Power>

Current state of development and perspectives

PHS is considered a mature technology. Alternative, lower-impact designs have been studied—including using natural or mined underground storage areas for the lower elevation reservoir—but are still at a development stage (NREL, 2010).

Most common ES applications

PHS is only cost-effective for very large amounts of storage. This means that it is appropriate for providing energy management and backup capacity for large RE installations. It can be constructed at large capacities of hundreds or thousands of megawatts and discharged over long periods of time (4 to 24 hours), meaning that it can be used in combination with solar PV energy during the nighttime, or wind power during extended periods of low wind. PHS is a predictable resource, but cannot be used in a matter of seconds—therefore, it is not appropriate for improving power quality.

For conventional energy uses, PHS is most appropriate for systems that have a large swing between peak electrical demand and low electrical demand—typically large, mainland grids with demand greater than 1,000MW (IRENA, 2012). This is because the large capacity would be greater than necessary for small grids, or grids that produce energy at roughly the same cost all the time.

A.6 Compressed Air Energy Storage

Compressed Air Energy Storage (CAES) technology can offer very large amounts of storage for thirty years with low capital costs and operations and maintenance costs. As a result the fixed cost of CAES per kWh is very low (the lowest of all ES technologies). The drawback is that it is relatively inefficient, which means that more electricity will be wasted in the process of 'charging' CAES.

CAES uses fossil fuels in a conventional gas turbine technology to produce electricity, which limits the environmental benefits of the technology. For this reason, it is sometimes overlooked as ES system for RE. However, it is properly considered a hybrid generation/storage system because it stores energy in the form of compressed air and requires combustion in a gas turbine (NREL, 2010).

CAES can be paired with RE to compress the air that improves the efficiency of conventional generation.

Functioning

CAES provides ES in a similar way to PHS. CAES functions by using electricity produced during off-peak hours or by intermittent renewables when their resource is available to drive a pump that injects air at high pressure into underground geologic formations, such as salt caverns. When demand for electricity is high or intermittent RE is not available, the pressurized air is released from underground and used to help power natural gas-fired turbines. Pressurized air is significantly more combustible than air at normal atmospheric pressures. This allows the turbines to generate electricity using significantly less natural gas (Pew, 2009). The figure below shows a schematic of how CAES functions:

Figure A.6: Schematic of Compressed Air Energy Storage

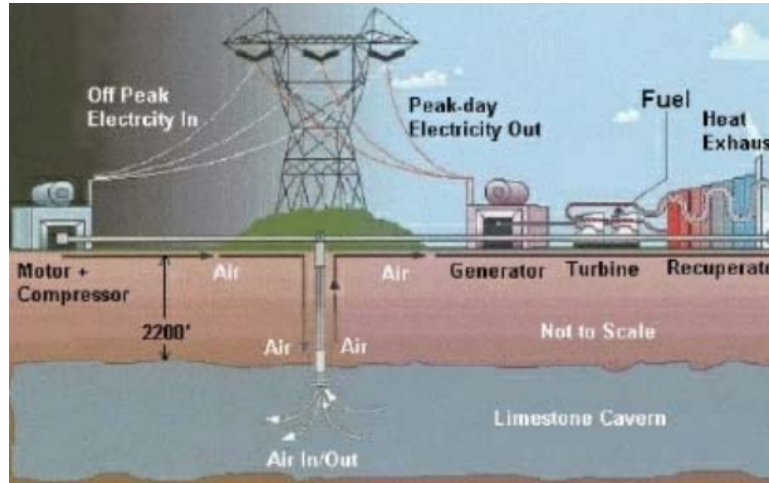

Source:EPRI, 2010

Current state of development and perspectives

There have only been two successful large-scale CAES installations worldwide—one in Alabama with a rated capacity of 110MW, and the other in Germany with a rated capacity of 290MW (DoE, 2012). However, the underlying technologies are based upon traditional equipment. For this reason, CAES is generally considered a mature technology (Pew, 2009).

The challenge of large-scale CAES is finding appropriate sites to locate the installation. The two operating commercial CAES projects are located near underground salt caverns (NREL, 2010). This does not mean that other, non-salt, underground formations would not be suitable; however, current commercial CAES technology requires some type of underground formation to store pressurized air in. For this reason, above-ground CAES and mini-CAES are promising areas of development for CAES. These CAES technologies are similar to traditional CAES technologies except that compressed air is stored in smaller, above-ground tanks (IRENA, 2012).

Most common ES applications

CAES, similar to PHS, is most appropriate for large grids located near geological formations appropriate for storing compressed air underground. This is because of its

large size and specific siting needs. CAES can provide for energy management and backup capacity services to large scale renewable installations in large grids because they can be constructed in capacities of a few hundred megawatts, and can be discharged over long (4-24 hours) periods of time (Pew, 2009). CAES performs the same services for conventional energy.

A.7 Thermal Energy Storage

There are two different methods for deploying TES:

‘Generating TES’ stores thermal energy from the sun as thermal energy (heat) and then later converts it to electricity in a conventional thermal generator

‘End-use TES’ uses thermal energy as a substitute for electricity in applications such as electric cooling or heating (Denholm, 2010).

All generating TES technologies, with the exception of one pilot project in Spain, are still experimental. End-use TES technologies do not discharge electricity, so they cannot be easily compared with other ES technologies. Therefore, there are no reliable estimates for capital costs or O&M costs for TES.

TES is sometimes ignored as an electricity storage technology, because it is inefficient to convert heat to electricity, store it, and then discharge it. However, TES that leaves energy in the thermal state until it is converted to electricity or uses thermal energy to substitute electricity can be the very efficient.

Functioning of generating TES

Generating TES uses a synthetic oil or molten salt to store energy from the sun collected by solar thermal power plants in the form of heat. The heat is converted to electricity when the sun is not available to enable smooth power output and to extend power production for one to ten hours.

Round trip efficiency is difficult to measure for generating TES. One of the major issues with electricity storage is efficiency losses. Electricity is a high “quality” source of energy, and transforming electricity into a stored medium and back incurs considerable losses. As a result, round trip efficiency may appear low for TES systems. For this reason, generating TES technology stores energy as thermal energy, and then converts it

to electricity when it is needed—as opposed to converting thermal energy to electricity, storing it, and then discharging it. Thermal energy is a much lower quality form of energy, but can be stored with much higher efficiency.

In a Concentrated Solar Power (CSP) plant, for example, thermal energy is stored as heat before conversion to electricity. As a result, the round trip efficiency of CSP thermal storage may be close to 100 percent, much higher than any electricity storage technology. However, CSP thermal storage can only store thermal energy produced from the solar field, as opposed to other storage technologies that can store electricity produced from any source.

Functioning of end-use TES

End-use TES stores electricity from off-peak periods through storing heat or cold in underground aquifers, water or ice tanks, or other storage materials. The stored heat or cold is then used to reduce the electricity consumption of building heating or air conditioning systems during times of peak demand. End-use TES is most cost-effective in regions with mild temperatures and relatively low humidity (Denholm, 2010).

Current state of development and perspectives of generating TES

Thermal energy storage is a developing technology. The only commercial demonstration of TES integrated with a solar thermal power plant currently in operation is AndaSol One, which is located in Spain. The AndaSol one plant uses synthetic oil as the storage medium.

Research to develop new types of molten salts and synthetic oils has the greatest potential to improve TES. Institutions such as the Sandia National Laboratory are currently researching new molten salts and synthetic oils to increase the efficiency of the technology (Sandia, 2012).

Current state of development and perspectives of end-use TES

There are end-use TES pilot projects installed in the United States, United Kingdom, Germany, and Scandinavia. Additionally, about eight percent of residential water heaters in the United Kingdom use an end-use TES system that is operated at night in order to heat water throughout the day and reduce peak electricity consumption (Pew,

2009). Continued experimentation with more efficient and novel applications of end-use TES are likely to continue to bring additional end-use TES technologies to the market.

Most common ES applications for TES

Generating TES is the TES technology that is best paired with RE—particularly solar technologies. TES provides useful energy management services to solar technologies. This is particularly true for CSP, because of the high levels of heat that it produces. In addition, TES can discharge for long period of time, making it particularly apt for solar RE technologies that are unavailable during the night.

Generating TES is not appropriate for other forms of renewables that do not generate heat (for example, wind power) or for conventional generation. However, end-use TES may be useful for storing heat or cold produced with electricity generated inexpensively by wind during off-peak hours.

A.8 Flywheels

Flywheels are a very useful technology for power quality applications; however, they are not the most appropriate technology for direct use in combination with RE because they do not provide backup power or energy management services. They are, however, a trusted way of storing energy to be accessed in short bursts later. They use a technology that is central to many conventional engines. Flywheels are found in automobile engines and outboard motors using inertia to keep engines spinning smoothly.

Although they have high capital costs, flywheels have high roundtrip efficiency and a long lifespan.

Functioning

The technology works by storing kinetic energy in large heavy spinning disks known as flywheels. The discs are connected to a shaft that is powered by a conventional motor. That kinetic energy is stored by increasing the flywheel's rotational speed. The stored energy is converted back to electric energy when the generator applies friction to the flywheel, slowing the flywheel and transferring energy to the generator (Sandia, 2010). In advanced flywheel ES systems, a magnet levitates the flywheel, thus limiting

friction-related losses and wear. The figure below shows a schematic of how flywheels function.

Figure A.7: Schematic of Flywheel

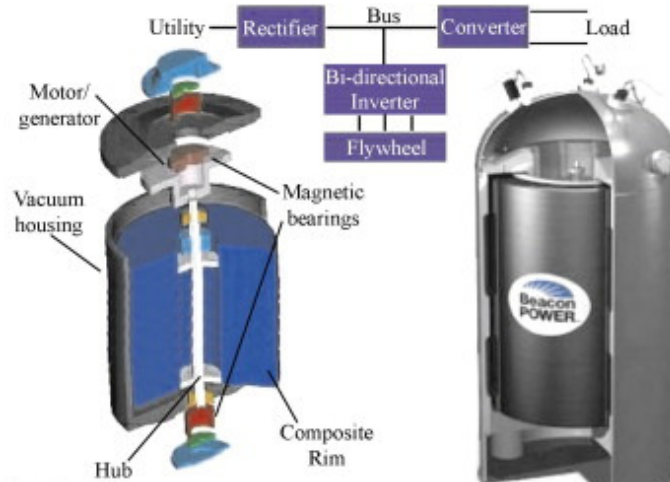

Source: Chen, H. et. al. “Progress in electrical energy storage system: A critical review” Progress In Natural Science 19(2009):3.

Current state of development and perspectives

Flywheels for short bursts of electricity are a mature and familiar technology in use all over the world. However, long-duration flywheels that would be able to discharge electricity for longer periods of time than current high-power flywheels are under development. High power flywheels could potentially be used as backup power. This would make flywheels potentially useful for RE; however, they are not yet commercially available (IRENA, 2010).

Most common ES applications

Flywheels are not directly useful for storing energy from intermittent RE in large amounts. They may be used, however, for improving power quality from RE sources. Flywheels can be used for power quality applications since they can charge and discharge quickly and frequently (Pew, 2009). This is useful for intermittent renewables that may provide fluctuating levels of power based on the strength of their resource—for example, if wind speed fluctuates.

A.9 Hydrogen Storage

Hydrogen storage, which uses electricity to produce hydrogen that can be converted back into electricity later, provides great flexibility for end-uses in the electricity sector and the transport sector. Hydrogen can be paired with RE to make hydrogen that can later be used to generate electricity. Hydrogen storage has a long lifespan and a long discharge; however, hydrogen has low efficiency and is not yet commercially proven. This explains its high capital cost and indicates that it will have a high LPMC. In addition, hydrogen fuel can be used to power vehicles or generate heat.

Functioning

Hydrogen storage uses electricity to split water into hydrogen and oxygen through electrolysis. The hydrogen can be stored and then, when electricity is needed, used for generating electricity via a hydrogen-powered combustion engine or a fuel cell (Pew, 2009). In addition, hydrogen can be used to power vehicles—either by burning it, or using a fuel cell to convert it to electricity.

A hydrogen storage system has three primary components: an electrolyser, which uses electricity to remove hydrogen from water; a storage tank, which captures and stores the hydrogen; and a fuel cell or hydrogen powered combustion engine, which uses hydrogen to generate electricity (IRENA, 2012). The figure below shows a schematic of how hydrogen storage functions.

Figure A.8: Schematic of Hydrogen Storage

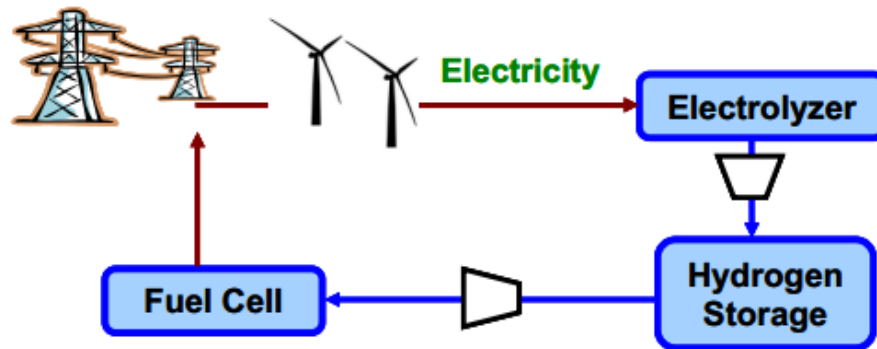

Source: D. Steward, G. Saur, M. Penev, and T. Ramsden. "Lifecycle Cost Analysis of Hydrogen Versus Other

Technologies for Electrical Energy Storage." NREL 2009 Accessed 10/15/2012 at:

<http://www.nrel.gov/docs/fy10osti/46719.pdf>

Current state of development and perspectives

Hydrogen storage for grid applications suffers from two significant problems: it is expensive to build, and has very low roundtrip efficiency. Low roundtrip efficiency is the result of energy lost in the process of converting electricity into hydrogen and then back into electricity. As a result, typical roundtrip efficiency values in pilot projects are in the range of 20 percent to 30 percent—much lower than the 70 to 95 percent efficiencies of other ES technologies (Pew, 2009). This means the hydrogen storage is still far from commercially attractive, and will likely not be for some time (IRENA, 2012).

Most common ES applications

Hydrogen storage is best paired with renewable energy in small grids to store energy used for energy management or power quality applications. Its ability to produce fuel that can be used for vehicles and heating makes it most appropriate in remote locations that may desire to remove the need for petroleum products altogether.

A.10 Superconducting Magnetic Energy Storage (SMES)

SMES is a new, yet promising technology. It stores power in cooled coils that can discharge electricity within milliseconds. However, it is not appropriate for use in

combination with RE because it cannot be used for backup power or energy management purposes. SMES has very high roundtrip efficiency and a long lifespan—but it is still experimental, and therefore likely to have high capital costs. Furthermore, operation and maintenance costs are high due to continual need for cooling. Similar to flywheels, SMES is used for power quality purposes only.

Functioning

SMES devices function by storing electricity in the magnetic field created by the flow of direct current in the SMES's coil. SMES systems consist of a refrigerated coil with many windings of superconducting wire that stores and releases energy with increases or decreases in the current flowing through the wire in short bursts. Additional SMES system components include power conditioning equipment and a cryogenic refrigeration system for cooling the coil.

SMES installations have no moving parts; however, SMES coils must be kept cool to a temperature below the temperature needed for superconductivity (-200°C)—referred to as the critical temperature. Once energy is stored, the current will not degrade, so energy can be stored as long as the system is kept cool (Sandia, 2010).

Current state of development and perspectives

SMES is a developing technology that holds promise as a very efficient option for improving power quality. For this reason, several utilities have invested in SMES demonstration projects larger than 1MW to provide power quality services. Utilities are especially interested in SMES for providing high quality power to manufacturing plants requiring ultra-reliable electricity, such as microchip fabrication facilities and data centers. However, SMES is not commercially available, and it will likely require several years of further research to lower capital costs and decrease the size of installations (Pew, 2009).

Most common ES applications

SMES installations, similar to flywheels, are not particularly useful for storing energy from intermittent RE in large amounts. SMES are, however, very effective for improving power quality because they provide short bursts of energy and can respond in

less than a second (IRENA, 2012). Therefore, SMES is best used for power quality applications in large grids that can afford high upfront costs and maintenance costs.

References

AES. "AES Installs First Energy Storage System in Chile." November, 2009. Accessed 09/04/2012 at: <http://newsroom.aes.com/phoenix.zhtml?c=202639&p=irol-newsArticle&ID=1357116&highlight=>

AES Energy Storage. "AES Combines Advanced Battery-Based Energy Storage with a Traditional Power Plant." May, 2012. Accessed 09/04/2012 at: <http://www.aesenergystorage.com/news/aes-combines-advanced-battery-based-energy-storage-traditional-power-plant.html>

American Physics Association. "Challenges of Electricity Storage Technologies." APS. 2007

Biller, David. "Rubenius eyeing two new energy storage sites with 1-1.5GW." BN Americas. November, 2011. Accessed on accessed 09/05/2012 at: <http://www.bnamericas.com/news/electricpower/rubenius-eyeing-two-new-energy-storage-sites-with-1-15gw>

Black and Veatch Holding Company. "Cost and Performance Data for Power Generation." 2012. Accessed 10/27/2012 at: <http://bv.com/docs/reports-studies/nrel-cost-report.pdf>

Castalia. "Options to Bring Down the Cost of Electricity in Jamaica", 2011 at [http://www.castalia-advisors.com/files/Options to Bring Down Electricity Costs in Jamaica Castalia.pdf](http://www.castalia-advisors.com/files/Options_to_Bring_Down_Electricity_Costs_in_Jamaica_Castalia.pdf)

Conservacion Patagonica. "Renewable Energy System." Accessed 09/04/2012 at: http://www.patagonialandtrust.org/buildingthepark_publicaccess_energy.htm

CME Group. "Henry Hub Natural Gas Futures." Accessed 11/27/2012 at: http://www.cmegroup.com/trading/energy/natural-gas/natural-gas_quotes_globex.html

CME Group. "Light Sweet Crude Oil (WTI) Futures. Accessed 11/27/2012 at: <http://www.cmegroup.com/trading/energy/crude-oil/light-sweet-crude.html>

Denholm, P. Ela, E. Kirby, B. Milligan, M. “The Role of Energy Storage with Renewable Electricity Generation.” NREL January, 2010

Department of Energy. “Energy Storage Database (beta).” Accessed September 20, 2012 at: <http://www.energystorageexchange.org/projects/>

EDIN. “Bonaire Plans to Generate 100% Renewable Energy.” 2011 Accessed 09/06/2012 at: <http://www.edinenergy.org/bonaire.html>

European Wind Energy Association. “The Economics of Wind Energy.” 2009 Accessed 11/05/2012 at: http://www.ewea.org/fileadmin/ewea_documents/documents/00_POLICY_document/Economics_of_Wind_Energy_March_2009_.pdf

IRENA. “Electricity Storage and Renewables for Island Power: A Guide for Decision Makers.” May, 2012

Glassmire, John. Conversation with John Glassmire which took place on September 26, 2012

International Energy Agency. “Access to Electricity.” Accessed 11/20/2021 at: <http://www.worldenergyoutlook.org/resources/energydevelopment/accesstoelectricity/>

Johnson, T. et.al. “Low Carbon Development for Mexico.” World Bank. Accessed 11/10/2012 at: <http://www.embarq.org/sites/default/files/LowCarbonDevelopmentMexico.pdf>

Lehmann, J., Spinadel, E. “Wind Hydrogen Energy Systems.” Accessed 09/05/2012 at: http://www.wwindea.org/technology/ch04/en/4_3_2.html

Mandel, J. “DOE Promotes Pumped Hydro as Option for Renewable Power Storage.” New York Times. October 15, 2010. Accessed 12/12/2012 at: <http://www.nytimes.com/gwire/2010/10/15/15greenwire-doe-promotes-pumped-hydro-as-option-for-renewa-51805.html?pagewanted=all>

Marchetti, Nino. “Mexico Gets 1 GW Of Clean Energy Storage.” Earth Techling. December 2010. Accessed on 09/05/2012 at: <http://www.earthtechling.com/2010/12/mexico-gets-1-gw-of-clean-energy-storage/>

Optimal Power Solutions Blog. “Bahamas Minister Phenton Neymour visits OPS microgrid system.” May 22, 2012. Accessed on 09/05/2012 at: <http://optimal-power-solutions.com/blog/2012/05/ops-microgrid-featured-by-bahamas-minister-phenton-neymour/>

Optimal Power Solutions Blog. “Upcoming Bahamas Island Renewable Power System” April 8, 2009. Accessed on 09/05/2012 at: <http://optimal-power-solutions.com/blog/2009/04/upcoming-bahamas-island-renewable-power-system/>

Price, Toby. “Galapagos Islands to boast hybrid renewable energy system.” Renewable Energy Magazine. August, 2012. Accessed on 09/04/2012 at: <http://www.renewableenergymagazine.com/article/galapagos-islands-to-boast-hybrid-renewable-energy-20120828>

Saft Batteries. “Saft energy storage system to support Caribbean island of Bonaire power grid in switch to eco-friendly generation.” February 2010. Accessed 09/06/2012 at: http://www.saftbatteries.com/SAFT/UploadedFiles/PressOffice/2010/CP_08-10_en.pdf

Trutschler, Dieter. “Success story from Grenada: off-grid solar installation saves fuel and associated costs.” Meeco Group. March, 2012. Accessed on 09/05/2012 at: <http://www.meeco.net/blog/2012/03/21/success-story-from-grenada-off-grid-solar-installation-saves-fuel-and-associated-costs/>

Williams, E. Yang, C. “Climate Change Policy Partnership.” January, 2009

Yepez-Garcia, R et. al. “Meeting the Electricity Supply/Demand Balance in Latin America and the Caribbean.” World Bank. 2010

Yunicos. “EDA and Yunicos Sign 25m Euro Deal.” August, 2012. Accessed on 12/14/12 at: http://www.yunicos.com/en/aboutus/press-releases/008-2012-08-09_gracios